

Reactor[®] 3 Proportioning Systems

3A8500D
EN

Electric, heated, plural component proportioner for spraying polyurethane foam and polyurea coatings. For indoor use only. Not approved for use in explosive atmospheres or hazardous (classified) locations. Only use with Reactor 3 heated hoses. For professional use only.



Important Safety Instructions

Read all warnings and instructions in this manual and in related manuals before using the equipment. Save these instructions.

See page 4 for model information including maximum working pressure.

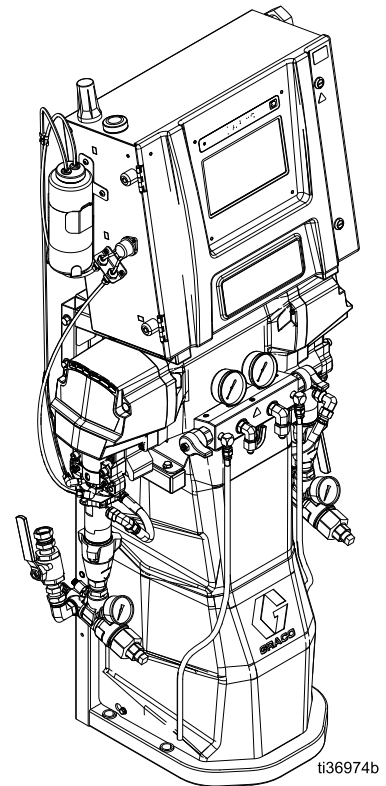

Contents

Supplied Manuals.....	3	Startup	29
Related Manuals	3	Operation	32
Models.....	4	Pressure Relief Procedure	32
Approvals	8	Jog Mode.....	33
Accessories.....	8	Purge Air Procedure.....	34
Warnings	9	Flush the Equipment.....	35
Important Isocyanate Information	13	Fluid Circulation	36
Typical Installation.....	15	Calibration	38
Typical Installation without		Spray.....	39
circulation	15	Shutdown	41
Typical Installation with system		Advance Display Module (ADM).....	42
fluid manifold to drum		Menu Bar	42
circulation	16	Home Screen	43
Typical Installation with gun		Diagnostic Screen.....	45
fluid manifold to drum		Logs Screens	46
circulation	17	Setup Screens	47
Component Identification	18	Advanced Screens.....	50
Proportioner.....	18	Maintenance	51
Electrical Enclosure.....	20	Preventative Maintenance	
Temperature Control Module		Schedule.....	51
(TCM).....	21	Tools Required for Maintenance	51
Motor Control Module (MCM).....	22	Proportioner Maintenance.....	51
Installation	23	Flush Inlet Strainer Screen	52
Location	23	Change ISO Pump Throat Seal Lubricant	
Tools Required for Installation.....	23	(TSL) Fluid.....	53
Assemble the Proportioner	23	Recycling and Disposal	53
Mount the System.....	24	Troubleshooting	54
Setup	25	Troubleshoot Errors	54
Grounding	25	LED Status Descriptions.....	55
Tools Required for Setup	25	Performance Charts	56
General Equipment Guidelines	25	Technical Specifications	58
Connect Power	26	California Proposition 65	62
Install Cell Module.....	27	Graco Extended Warranty for Reactor®	
Supply Wet Cups With Throat Seal		Components	63
Liquid (TSL®).....	28		
Connect Heated Hose to			
Proportioner	28		

Supplied Manuals

The following manuals and quick guides are shipped with the Reactor. Refer to these manuals and quick guides for detailed equipment information.

Manuals are also available at www.graco.com.

Manual	Description
3A8500	Reactor Proportioner Operation
3A8501	Reactor Proportioner, Repair and Parts
3A8505	Reactor Startup Quick Guide
3A8506	Reactor Shutdown Quick Guide

Related Manuals

The following manuals are for accessories used with the Reactor proportioner.

Manuals are available at www.graco.com.

Manual in English	Description
Feed System Manuals	
309852	Circulation and Return Tube Kit, Instructions–Parts
3A8502	T4 3:1 Ratio Transfer Pump, Operation and Parts
3A8503	E1 Transfer Pumps, Operation and Parts
Displacement Pump Manual	
309577	Electric Reactor Displacement Pump, Repair–Parts
Spray Gun Manuals	
309550	Fusion® AP Spray Gun, Instructions
3A7314	Fusion PC Spray Gun, Instructions
312666	Fusion CS Spray Gun, Instructions
309856	Fusion MP Spray Gun, Instructions–Parts
313213	Probler® P2 Gun, Instructions
Reactor Connect Manual	
3A8504	Reactor Connect, Instructions
Heated Hose Manual	
3A7683	Reactor Heated Hose (Reactor 3), Instructions

Models

Reactor E-20

	Model (Part Number)	E-20 Standard 7 kW (26R310)	E-20 Pro 7 kW (26R311)	E-20 Pro 10 kW (26R313)	E-20 Elite 10 kW (26R312)
Technical Information	Maximum Working Pressure	2000 psi (14 MPa, 140 bar)	2000 psi (14 MPa, 140 bar)	2000 psi (14 MPa, 140 bar)	2000 psi (14 MPa, 140 bar)
	Approximate Output / Cycle A+B	0.0104 gal (0.0395 L)	0.0104 gal (0.0395 L)	0.0104 gal (0.0395 L)	0.0104 gal (0.0395 L)
	Maximum Flow	20 lb/min (9.1 kg/min)	20 lb/min (9.1 kg/min)	20 lb/min (9.1 kg/min)	20 lb/min (9.1 kg/min)
	Max Heated Hose Length Supported	220 ft (67 m)	220 ft (67 m)	220 ft (67 m)	220 ft (67 m)
	Total System Load	12.9 kW	12.9 kW	15 kW	15 kW
	Primary Heater Load	7.6 kW	7.6 kW	9.6 kW	9.6 kW
	Full Load Peak Current	200-240 VAC 1Ø	56 A	56 A	65 A
200-240 VAC 3Ø Δ		36 A	36 A	39 A	39 A
350-415 VAC 3Ø Y		24 A	24 A	24 A	24 A
System Features	Ratio Monitoring				✓
	Reactor Connect App		✓	✓	✓
	Large-ported Recirculation Valves		✓	✓	✓
	Software includes auto pressure balancing and power management		✓	✓	✓
	Tank-level Dip Sticks		✓	✓	✓
	Large Inlet Strainer with Gauge, Pressure, and Temperature Sensors				✓
	Large Inlet Strainer with Gauge		✓	✓	
	Small Inlet Strainer, No Gauge	✓			
Packages	Externally Heated Hose Package, 1 x 50 ft (15.24 m)	ESR310★	ESR311★	ESR313★	ESR312◆●
	Externally Heated Hose Package, 2 x 100 ft (30.48 m)	EHR310★	EHR311★	EHR313★	EHR312◆●
	Internally Heated Hose Package, 1 x 50 ft (15.24 m)	ISR310★	ISR311★	ISR313★	ISR312◆●
	Internally Heated Hose Package, 2 x 100 ft (30.48 m)	IHR310★	IHR311★	IHR313★	IHR312◆●
	Core E1 with Internally Heated Hose Package, 1 x 50 ft (15.24 m)				CSR312◆●
	Core E1 with Internally Heated Hose Package, 2 x 100 ft (30.48 m)				CHR312◆●

◆ Includes engine CAN diagnostic cable.

★ Includes 10 ft (3.05 m) whip hose.

● Includes 20 ft (6.1 m) whip hose.

Reactor E-30

	Model (Part Number)	E-30 Standard 10 kW (26R330)	E-30 Pro 10 kW (26R331)	E-30 Pro 15 kW (26R333)	E-30 Elite 15 kW (26R332)
Technical Information	Maximum Working Pressure	2000 psi (14 MPa, 140 bar)	2000 psi (14 MPa, 140 bar)	2000 psi (14 MPa, 140 bar)	2000 psi (14 MPa, 140 bar)
	Approximate Output / Cycle A+B	0.0273 gal (0.0103 L)	0.0273 gal (0.0103 L)	0.0273 gal (0.0103 L)	0.0273 gal (0.0103 L)
	Maximum Flow	30 lb/min (13.5 kg/min)	30 lb/min (13.5 kg/min)	30 lb/min (13.5 kg/min)	30 lb/min (13.5 kg/min)
	Max Heated Hose Length Supported	320 ft (97.5 m)	320 ft (97.5 m)	320 ft (97.5 m)	320 ft (97.5 m)
	Total System Load	17.5 kW	17.5 kW	22.3 kW	22.3 kW
	Primary Heater Load	9.6 kW	9.6 kW	14.4 kW	14.4kW
	Full Load Peak Current	200-240 VAC 1Ø	76 A	76 A	97 A
200-240 VAC 3Ø Δ		49 A	49 A	59 A	59 A
350-415 VAC 3Ø Y		35 A	35 A	35 A	35 A
System Features	Ratio Monitoring				✓
	Reactor Connect App		✓	✓	✓
	Large-ported Recirculation Valves		✓	✓	✓
	Software includes auto pressure balancing and power management		✓	✓	✓
	Tank-level Dip Sticks		✓	✓	✓
	Large Inlet Strainer with Gauge, Pressure, and Temperature Sensors				✓
	Large Inlet Strainer with Gauge		✓	✓	
	Small Inlet Strainer, No Gauge	✓			
Packages	Externally Heated Hose Package, 1 x 50 ft (15.24 m)	ESR330★	ESR331★	ESR333★	ESR332◆●
	Externally Heated Hose Package, 2 x 100 ft (30.48 m)	EHR330★	EHR331★	EHR333★	EHR332◆●
	Internally Heated Hose Package, 1 x 50 ft (15.24 m)	ISR330★	ISR331★	ISR333★	ISR332◆●
	Internally Heated Hose Package, 2 x 100 ft (30.48 m)	IHR330★	IHR331★	IHR333★	IHR332◆●
	Core E1 with Internally Heated Hose Package, 1 x 50 ft (15.24 m)				CSR332◆●
	Core E1 with Internally Heated Hose Package, 2 x 100 ft (30.48 m)				CHR332◆●

◆ Includes engine CAN diagnostic cable.

★ Includes 10 ft (3.05 m) whip hose.

● Includes 20 ft (6.1 m) whip hose.

Reactor E-XP1

	Model (Part Number)	E-XP1 Standard 10 kW (26R320)	E-XP1 Pro 10 kW (26R321)	E-XP1 Elite 10 kW (26R322)
Technical Information	Maximum Working Pressure	3000 psi (20.7 MPa, 207 bar)	3000 psi (20.7 MPa, 207 bar)	3000 psi (20.7 MPa, 207 bar)
	Approximate Output / Cycle A+B	0.0104 gal (0.0395 L)	0.0104 gal (0.0395 L)	0.0104 gal (0.0395 L)
	Maximum Flow	2 gpm (7.6 lpm)	2 gpm (7.6 lpm)	2 gpm (7.6 lpm)
	Max Heated Hose Length Supported	220 ft (67 m)	220 ft (67 m)	220 ft (67 m)
	Total System Load	15 kW	15 kW	15 kW
	Primary Heater Load	9.6 kW	9.6 kW	9.6 kW
	Full Load Peak Current	200-240 VAC 1Ø	65 A	65 A
200-240 VAC 3Ø Δ		39 A	39 A	39 A
350-415 VAC 3Ø Y		24 A	24 A	24 A
System Features	Ratio Monitoring			✓
	Reactor Connect App		✓	✓
	Large-ported Recirculation Valves		✓	✓
	Software includes auto pressure balancing and power management		✓	✓
	Tank-level Dip Sticks		✓	✓
	Large Inlet Strainer with Gauge, Pressure, and Temperature Sensors			✓
	Large Inlet Strainer with Gauge		✓	
	Small Inlet Strainer, No Gauge	✓		
Packages	Externally Heated Hose Package, 1 x 50 ft (15.24 m)	ESR320★	ESR321★	ESR322◆●
	Externally Heated Hose Package, 2 x 100 ft (30.48 m)	EHR320★	EHR321★	EHR322◆●
	Internally Heated Hose Package, 1 x 50 ft (15.24 m)	ISR320★	ISR322★	ISR322◆●
	Internally Heated Hose Package, 2 x 100 ft (30.48 m)	IHR320★	IHR321★	IHR322◆●
	Core E1 with Internally Heated Hose Package, 1 x 50 ft (15.24 m)			CSR322◆●
	Core E1 with Internally Heated Hose Package, 2 x 100 ft (30.48 m)			CHR322◆●

◆ Includes engine CAN diagnostic cable.

★ Includes 10 ft (3.05 m) whip hose.

● Includes 20 ft (6.1 m) whip hose.

Reactor E-XP2

Model (Part Number)	E-XP2 Standard 15 kW (26R340)	E-XP2 Pro 15 kW (26R341)	E-XP2 Elite 15 kW (26R342)	
Technical Information	Maximum Working Pressure	3500 psi (24.1 MPa, 241 bar)	3500 psi (24.1 MPa, 241 bar)	3500 psi (24.1 MPa, 241 bar)
	Approximate Output / Cycle A+B	0.0204 gal (0.0771 L)	0.0204 gal (0.0771 L)	0.0204 gal (0.0771 L)
	Maximum Flow	2.1 gpm (7.9 lpm)	2.1 gpm (7.9 lpm)	2.1 gpm (7.9 lpm)
	Max Heated Hose Length Supported	320 ft (97.5 m)	320 ft (97.5 m)	320 ft (97.5 m)
	Total System Load	22.3 kW	22.3 kW	22.3 kW
	Primary Heater Load	14.4 kW	14.4 kW	14.4 kW
	Full Load Peak Current	200-240 VAC 1Ø	97 A	97 A
200-240 VAC 3Ø Δ		59 A	59 A	59 A
350-415 VAC 3Ø Y		35 A	35 A	35 A
System Features	Ratio Monitoring			✓
	Reactor Connect App		✓	✓
	Large-ported Recirculation Valves		✓	✓
	Software includes auto pressure balancing and power management		✓	✓
	Tank-level Dip Sticks		✓	✓
	Large Inlet Strainer with Gauge, Pressure, and Temperature Sensors			✓
	Large Inlet Strainer with Gauge		✓	
	Small Inlet Strainer, No Gauge	✓		
Packages	Externally Heated Hose Package, 1 x 50 ft (15.24 m)	ESR340★	ESR341★	ESR342◆●
	Externally Heated Hose Package, 2 x 100 ft (30.48 m)	EHR340★	EHR341★	EHR342◆●
	Internally Heated Hose Package, 1 x 50 ft (15.24 m)	ISR340★	ISR341★	ISR342◆●
	Internally Heated Hose Package, 2 x 100 ft (30.48 m)	IHR340★	IHR341★	IHR342◆●
	Core E1 with Internally Heated Hose Package, 1 x 50 ft (15.24 m)			CSR342◆●
	Core E1 with Internally Heated Hose Package, 2 x 100 ft (30.48 m)			CHR342◆●

◆ Includes engine CAN diagnostic cable.

★ Includes 10 ft (3.05 m) whip hose.

● Includes 20 ft (6.1 m) whip hose.

Approvals

Intertek approvals apply to proportioners without hoses.

Proportioner Approvals:



Intertek
9902471

Conforms to ANSI/UL Std. 499
Certified to CAN/CSA Std. C22.2 No. 88

CE

UK
CA





EAC









Accessories

Kit Number	Description
20A677	Engine CAN Kit
24M174	Drum Level Sticks
20A676	Light Tower Kit
18E191	Off-Ratio Kits
18E192	
18E154	Air Manifold Kit
18E211	Cellular Mobile Remote Mounting Kit

Warnings

The following warnings are for the setup, use, grounding, maintenance, and repair of this equipment. The exclamation point symbol alerts you to a general warning and the hazard symbols refer to procedure-specific risks. When these symbols appear in the body of this manual or on warning labels, refer back to these Warnings. Product-specific hazard symbols and warnings not covered in this section may appear throughout the body of this manual where applicable.

<h2>DANGER</h2>	
 	<p>SEVERE ELECTRIC SHOCK HAZARD</p> <p>This equipment can be powered by more than 240 V. Contact with this voltage will cause death or serious injury.</p> <ul style="list-style-type: none"> • Turn off and disconnect power at main switch before disconnecting any cables and before servicing equipment. • This equipment must be grounded. Connect only to grounded power source. • All electrical wiring must be done by a qualified electrician and comply with all local codes and regulations.
<h2>WARNING</h2>	
	<p>TOXIC FLUID OR FUMES</p> <p>Toxic fluids or fumes can cause serious injury or death if splashed in the eyes or on skin, inhaled or swallowed.</p> <ul style="list-style-type: none"> • Read Safety Data Sheets (SDSs) for handling instructions and to know the specific hazards of the fluids you are using, including the effects of long-term exposure. • When spraying, servicing equipment, or when in the work area, always keep work area well ventilated and always wear appropriate personal protective equipment. See Personal Protective Equipment warnings in this manual. • Store hazardous fluid in approved containers, and dispose of it according to applicable guidelines.
	<p>PERSONAL PROTECTIVE EQUIPMENT</p> <p>Always wear appropriate personal protective equipment and cover all skin when spraying, servicing equipment, or when in the work area. Protective equipment helps prevent serious injury, including long-term exposure; inhalation of toxic fumes, mists or vapors; allergic reaction; burns; eye injury and hearing loss. This protective equipment includes but is not limited to:</p> <ul style="list-style-type: none"> • A properly fitting respirator, which may include a supplied-air respirator, chemically impermeable gloves, protective clothing and foot coverings as recommended by the fluid manufacturer and local regulatory authority. • Protective eyewear and hearing protection.

<h1>WARNING</h1>	
    	<p>SKIN INJECTION HAZARD</p> <p>High-pressure fluid from gun, hose leaks, or ruptured components will pierce skin. This may look like just a cut, but it is a serious injury that can result in amputation. Get immediate surgical treatment.</p> <ul style="list-style-type: none"> • Do not spray without tip guard and trigger guard installed. • Engage trigger lock when not spraying. • Do not point gun at anyone or at any part of the body. • Do not put your hand over the spray tip. • Do not stop or deflect leaks with your hand, body, glove, or rag. • Follow the Pressure Relief Procedure when you stop spraying and before cleaning, checking, or servicing equipment. • Tighten all fluid connections before operating the equipment. • Check hoses and couplings daily. Replace worn or damaged parts immediately.
   	<p>FIRE AND EXPLOSION HAZARD</p> <p>Flammable fumes, such as solvent and paint fumes, in work area can ignite or explode. Paint or solvent flowing through the equipment can cause static sparking. To help prevent fire and explosion:</p> <ul style="list-style-type: none"> • Use equipment only in well ventilated area. • Eliminate all ignition sources; such as pilot lights, cigarettes, portable electric lamps, and plastic drop cloths (potential static sparking). • Ground all equipment in the work area. See Grounding instructions. • Never spray or flush solvent at high pressure. • Keep work area free of debris, including solvent, rags and gasoline. • Do not plug or unplug power cords, or turn power or light switches on or off when flammable fumes are present. • Use only grounded hoses. • Hold gun firmly to side of grounded pail when triggering into pail. Do not use pail liners unless they are anti-static or conductive. • Stop operation immediately if static sparking occurs or you feel a shock. Do not use equipment until you identify and correct the problem. • Keep a working fire extinguisher in the work area.

WARNING



THERMAL EXPANSION HAZARD

Fluids subjected to heat in confined spaces, including hoses, can create a rapid rise in pressure due to the thermal expansion. Over-pressurization can result in equipment rupture and serious injury.



- Open a valve to relieve the fluid expansion during heating.
- Replace hoses proactively at regular intervals based on your operating conditions.







PRESSURIZED ALUMINUM PARTS HAZARD

Use of fluids that are incompatible with aluminum in pressurized equipment can cause serious chemical reaction and equipment rupture. Failure to follow this warning can result in death, serious injury, or property damage.

- Do not use 1,1,1-trichloroethane, methylene chloride, other halogenated hydrocarbon solvents or fluids containing such solvents.
- Do not use chlorine bleach.
- Many other fluids may contain chemicals that can react with aluminum. Contact your material supplier for compatibility.

WARNING

 	<p>EQUIPMENT MISUSE HAZARD</p> <p>Misuse can cause death or serious injury.</p> <ul style="list-style-type: none"> • Do not operate the unit when fatigued or under the influence of drugs or alcohol. • Do not exceed the maximum working pressure or temperature rating of the lowest rated system component. See Technical Specifications in all equipment manuals. • Use fluids and solvents that are compatible with equipment wetted parts. See Technical Specifications in all equipment manuals. Read fluid and solvent manufacturer's warnings. For complete information about your material, request Safety Data Sheets (SDSs) from distributor or retailer. • Do not leave the work area while equipment is energized or under pressure. • Turn off all equipment and follow the Pressure Relief Procedure when equipment is not in use. • Check equipment daily. Repair or replace worn or damaged parts immediately with genuine manufacturer's replacement parts only. • Do not alter or modify equipment. Alterations or modifications may void agency approvals and create safety hazards. • Make sure all equipment is rated and approved for the environment in which you are using it. • Use equipment only for its intended purpose. Call your distributor for information. • Route hoses and cables away from traffic areas, sharp edges, moving parts, and hot surfaces. • Do not kink or over bend hoses or use hoses to pull equipment. • Keep children and animals away from work area. • Comply with all applicable safety regulations.
 	<p>MOVING PARTS HAZARD</p> <p>Moving parts can pinch, cut or amputate fingers and other body parts.</p> <ul style="list-style-type: none"> • Keep clear of moving parts. • Do not operate equipment with protective guards or covers removed. • Equipment can start without warning. Before checking, moving, or servicing equipment, follow the Pressure Relief Procedure and disconnect all power sources.
	<p>BURN HAZARD</p> <p>Equipment surfaces and fluid that is heated can become very hot during operation. To avoid severe burns:</p> <ul style="list-style-type: none"> • Do not touch hot fluid or equipment.

Important Isocyanate Information

Isocyanates (ISO) are catalysts used in two component materials.

Isocyanate Conditions

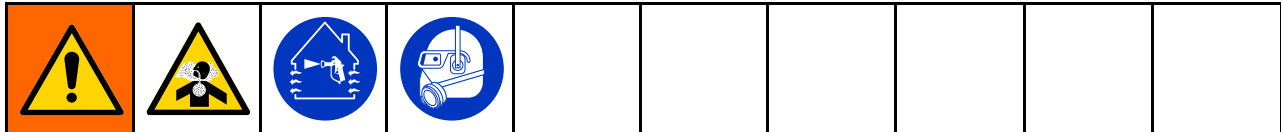



Spraying or dispensing fluids that contain isocyanates creates potentially harmful mists, vapors, and atomized particulates.



- Read and understand the fluid manufacturer’s warnings and Safety Data Sheets (SDSs) to know specific hazards and precautions related to isocyanates.
- Use of isocyanates involves potentially hazardous procedures. Do not spray with this equipment unless you are trained, qualified, and have read and understood the information in this manual and in the fluid manufacturer’s application instructions and SDSs.
- Use of incorrectly maintained or mis-adjusted equipment may result in improperly cured material, which could cause off gassing and offensive odors. Equipment must be carefully maintained and adjusted according to instructions in the manual.
- To prevent inhalation of isocyanate mists, vapors and atomized particulates, everyone in the work area must wear appropriate respiratory protection. Always wear a properly fitting respirator, which may include a supplied-air respirator. Ventilate the work area according to instructions in the fluid manufacturer’s SDSs.
- Avoid all skin contact with isocyanates. Everyone in the work area must wear chemically impermeable gloves, protective clothing and foot coverings as recommended by the fluid manufacturer and local regulatory authority. Follow all fluid manufacturer recommendations, including those regarding handling of contaminated clothing. After spraying, wash hands and face before eating or drinking.
- Hazard from exposure to isocyanates continues after spraying. Anyone without appropriate personal protective equipment must stay out of the work area during application and after application for the time period specified by the fluid manufacturer. Generally this time period is at least 24 hours.
- Warn others who may enter work area of hazard from exposure to isocyanates. Follow the recommendations of the fluid manufacturer and local regulatory authority. Posting a placard such as the following outside the work area is recommended:



Material Self-Ignition

				
<p>Some materials may become self-igniting if applied too thick. Read material manufacturer's warnings and Safety Data Sheets (SDSs).</p>				

Keep Components A and B Separate

				
<p>Cross-contamination can result in cured material in fluid lines which could cause serious injury or damage to equipment. To prevent cross-contamination:</p> <ul style="list-style-type: none"> • Never interchange component A and component B wetted parts. • Never use solvent on one side if it has been contaminated from the other side. 				

Changing Materials

NOTICE				
<p>Changing the material types used in your equipment requires special attention to avoid equipment damage and downtime.</p> <ul style="list-style-type: none"> • When changing materials, flush the equipment multiple times to ensure it is thoroughly clean. • Always clean the fluid inlet strainers after flushing. • Check with your material manufacturer for chemical compatibility. • When changing between epoxies and urethanes or polyureas, disassemble and clean all fluid components and change hoses. Epoxies often have amines on the B (hardener) side. Polyureas often have amines on the B (resin) side. 				

Moisture Sensitivity of Isocyanates

Exposure to moisture (such as humidity) will cause ISO to partially cure, forming small, hard, abrasive crystals that become suspended in the fluid. Eventually a film will form on the surface and the ISO will begin to gel, increasing in viscosity.

NOTICE				
<p>Partially cured ISO will reduce performance and the life of all wetted parts.</p> <ul style="list-style-type: none"> • Always use a sealed container with a desiccant dryer in the vent, or a nitrogen atmosphere. Never store ISO in an open container. • Keep the ISO pump wet cup or reservoir (if installed) filled with appropriate TSL fluid. The TSL fluid creates a barrier between the ISO and the atmosphere. • Use only moisture-proof hoses compatible with ISO. • Never use reclaimed solvents, which may contain moisture. Always keep solvent containers closed when not in use. • Always lubricate threaded parts with an appropriate lubricant when reassembling. • Cycle material through the Reactor at least once per week when wetted and sitting idle. Use the A-side transfer pump to flush material through the A-side outlet manifold recirculation fitting. See Flush the Equipment, page 35. • The Reactor should not be stored after ingesting air or running out of material. Prior to storage, follow the Purge Air procedure in your operation manual. 				

NOTE: The amount of film formation and rate of crystallization varies depending on the blend of ISO, the humidity, and the temperature.

Foam Resins with 245 fa Blowing Agents

Some foam blowing agents will froth at temperatures above 90°F (33°C) when not under pressure, especially if agitated. To reduce frothing, minimize preheating in a circulation system.

Typical Installation

Typical Installation without circulation

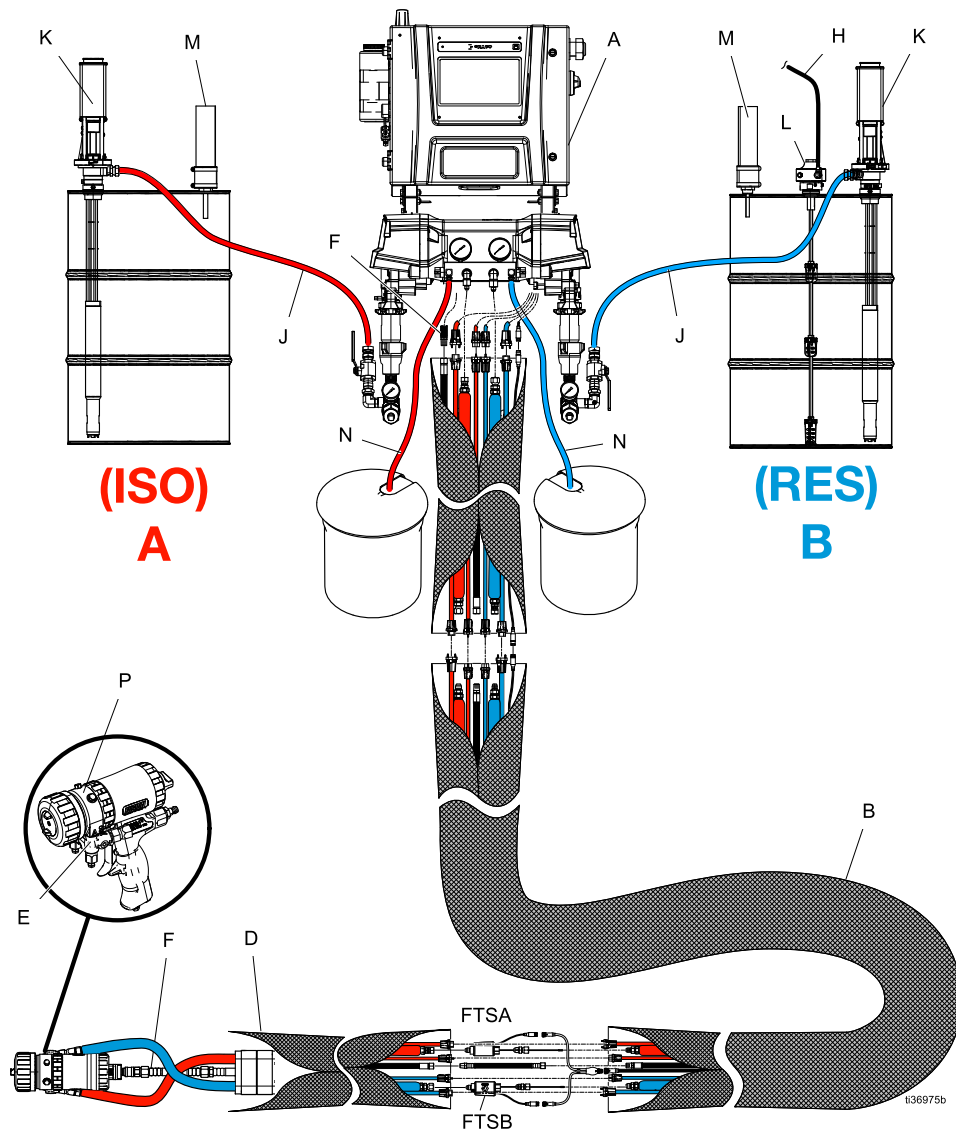

Figure 1

Key

A	Reactor Proportioner	H ❖	Agitator Air Supply Line	N	Bleed Lines
B *❖	Heated Hose Bundle	J ❖	Fluid Supply Lines	P ❖	Gun Fluid Manifold
D ❖	Heated Whip Hose	K ❖	Transfer Pumps	FTSA*❖	Fluid Temperature Sensor (A side)
E ❖	Gun Manifold	L ❖	Agitator	FTSB *❖	Fluid Temperature Sensor (B side)
F ❖	Gun Air Supply Hose	M ❖	Desiccant Dryers		

* Shown exposed for clarity. Wrap with tape during operation.

❖Not Included.

Typical Installation with system fluid manifold to drum circulation

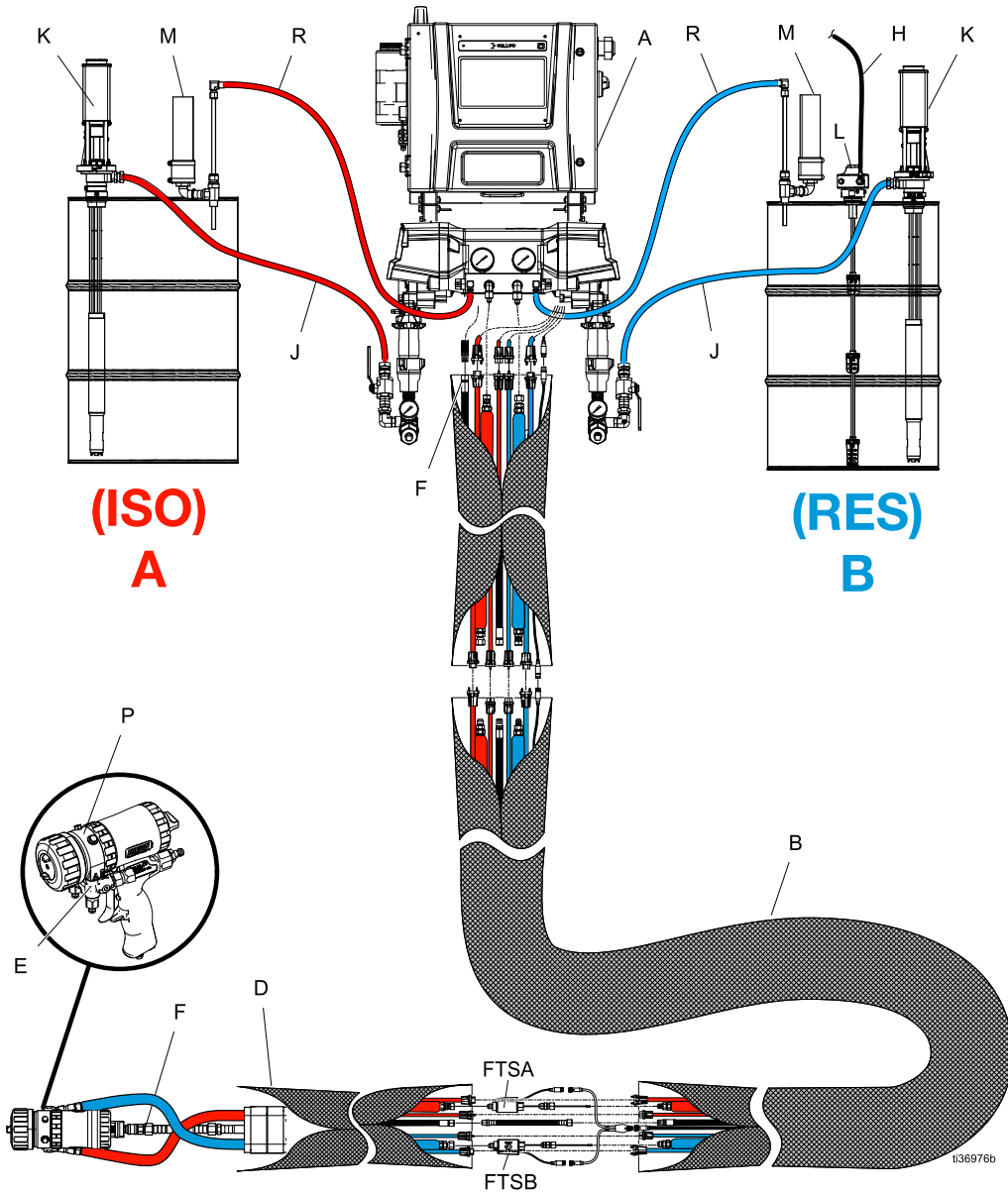

Figure 2

Key

- | | | | | | |
|------|----------------------|-----|--------------------------|---------|-----------------------------------|
| A | Reactor Proportioner | H ❖ | Agitator Air Supply Line | P ❖ | Gun Fluid Manifold |
| B* ❖ | Heated Hose Bundle | J ❖ | Fluid Supply Lines | R ❖ | Recirculation Lines |
| D ❖ | Heated Whip Hose | K ❖ | Transfer Pumps | FTSA *❖ | Fluid Temperature Sensor (A side) |
| E ❖ | Gun Manifold | L ❖ | Agitator | FTSB *❖ | Fluid Temperature Sensor (B side) |
| F ❖ | Gun Air Supply Hose | M ❖ | Desiccant Dryers | | |

* Shown exposed for clarity. Wrap with tape during operation.

❖ Not included.

Typical Installation with gun fluid manifold to drum circulation

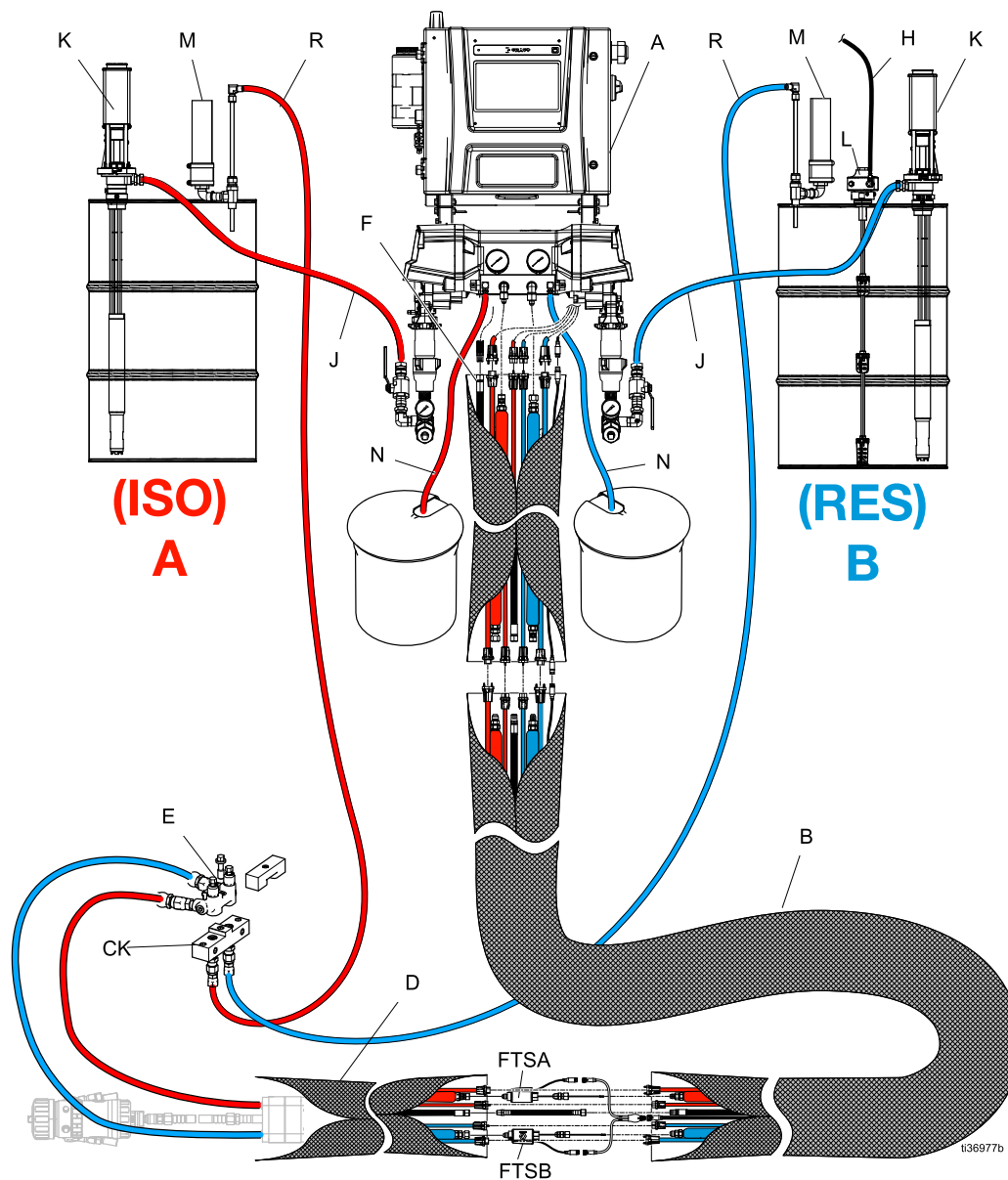

Figure 3

Key

A	Reactor Proportioner	H ❖	Agitator Air Supply Line	N	Bleed Lines
B* ❖	Heated Hose Bundle	J ❖	Fluid Supply Lines	R ❖	Recirculation Lines
D ❖	Heated Whip Hose	K ❖	Transfer Pumps	CK ❖	Circulation Block (accessory)
E ❖	Gun Manifold	L ❖	Agitator	FTSA *❖	Fluid Temperature Sensor (A side)
F ❖	Gun Air Supply Hose	M ❖	Desiccant Dryers	FTSB *❖	Fluid Temperature Sensor (B side)

* Shown exposed for clarity. Wrap with tape during operation.

❖ Not included.

Component Identification

Proportioner

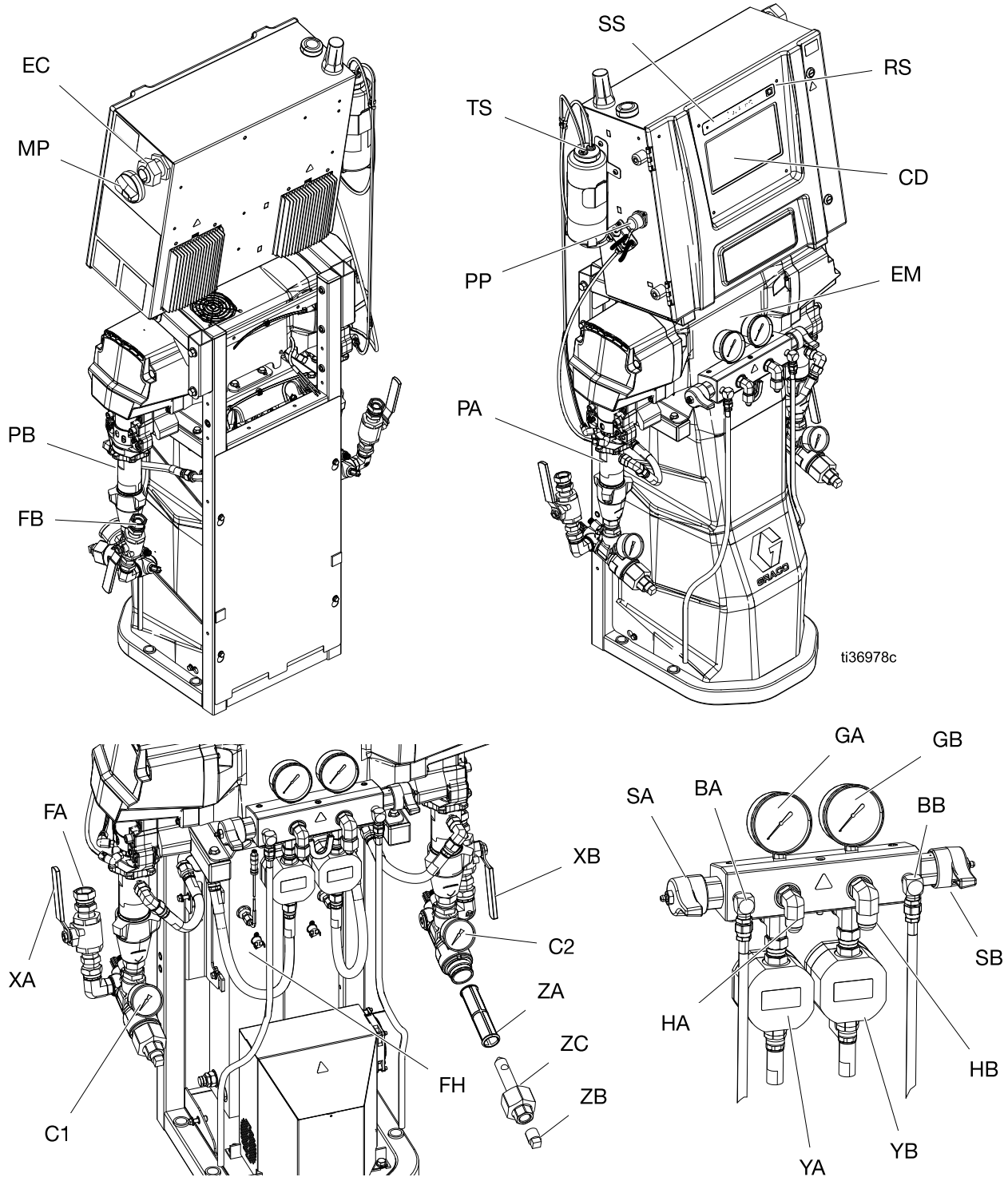

Key

BA	ISO Side Pressure Relief Outlet
BB	RES Side Pressure Relief Outlet
C1	ISO Side Inlet Pressure Gauge
C2	RES Side Inlet Pressure Gauge
CD	Advanced Display Module (ADM)
EC	Electrical Cord Strain Relief
EM	Electric Motor
FA	ISO Side Inlet Fitting
FB	RES Side Inlet Fitting
FH	Fluid Heaters
GA	ISO Side Pressure Gauge
GB	RES Side Pressure Gauge
HA	ISO Side Hose Connection
HB	RES Side Hose Connection
MP	Main Power Switch
PA	ISO Side Pump
PB	RES Side Pump
PP	ISO Lubrication Pump
RS	Red Stop Button
SA	ISO Side Pressure Relief/Spray Valve
SB	RES Side Pressure Relief/Spray Valve
SS	System LED Status Light
TS	ISO Lubrication Reservoir
XA	ISO Side Fluid Inlet Valve
XB	RES Side Fluid Inlet Valve
YA	Flow Meter (ISO side, Elite models only)
YB	Flow Meter (RES side, Elite models only)
ZA	Inlet Strainer Screen
ZB	Inlet Strainer Drain Plug
ZC	Inlet Strainer Cap

Electrical Enclosure

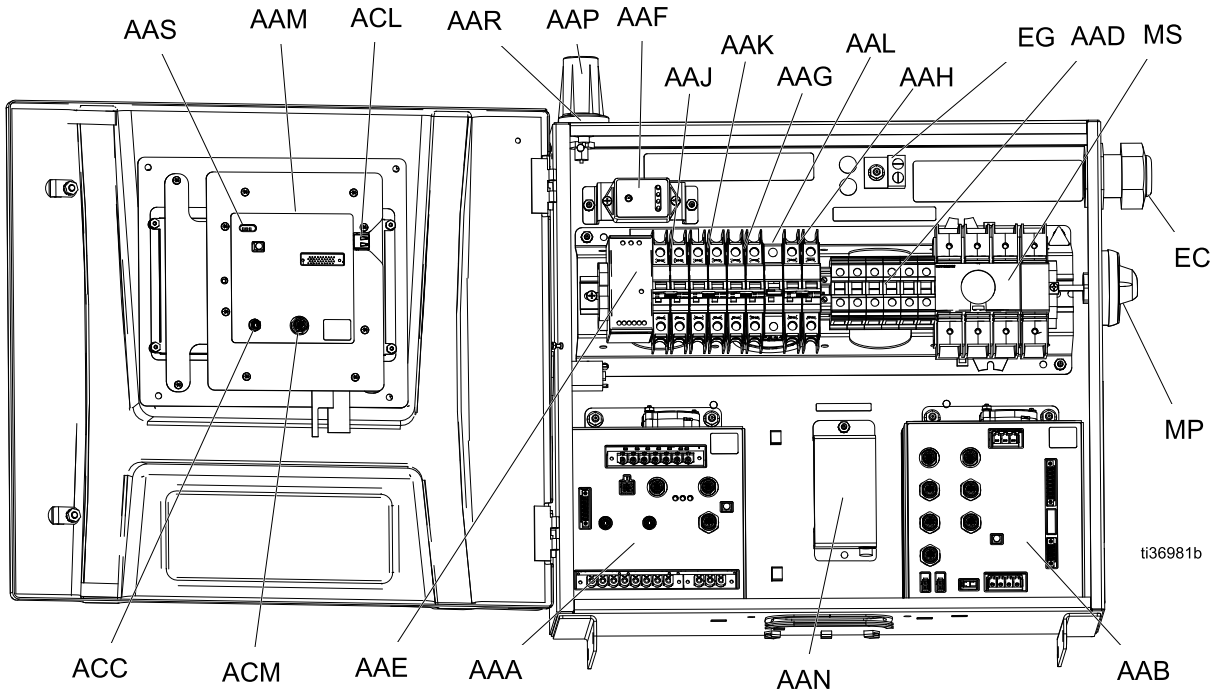

AAA	Temperature Control Module (TCM)	AAP *	Cellular Antenna
AAB	Motor Control Module (MCM)	AAR *	GPS Antenna
AAD	Wiring Terminal Blocks	AAS	ADM LED Status Lights
AAE	24V Power Supply	ACC	Reactor Connect Module Cable Connection
AAF	Surge Protector	ACL	ADM USB Port
AAG	Transformer Breaker	ACM	ADM CAN Cable Connection
AAH	Motor Breaker	EC	Incoming Power Cord Strain Relief
AAJ	A-Side Heat Breaker	EG	Incoming Power Ground Terminal
AAK	B-Side Heat Breaker	MP	Main Power Disconnect Knob
AAL	Hose Breaker	MS	Main Power Disconnect Switch
AAM	Advance Display Module (ADM)		
AAN *	Reactor Connect App Module		

* Not included on all models.

Temperature Control Module (TCM)

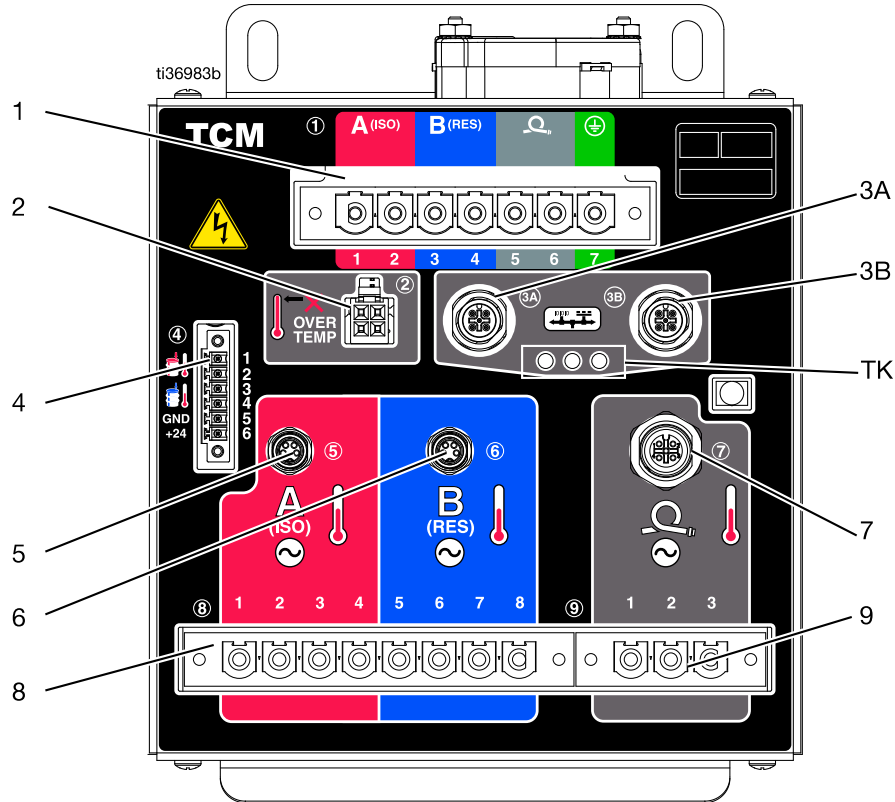

Ref. Description

- 1 Main Power Input
- 2 Heater Over-Temperature Inputs
- 3A CAN Communications Connections
- 3B CAN Communications Connections
- 4 A/B Inlet Temperatures and 24 VDC Power Supply Input
- 5 A Heater Temperature Input
- 6 B Heater Temperature Input
- 7 A/B Hose Temperature Inputs
- 8 A/B Heater Power Outputs
- 9 A/B Hose Power Outputs
- TK TCM LED Status Lights

Motor Control Module (MCM)

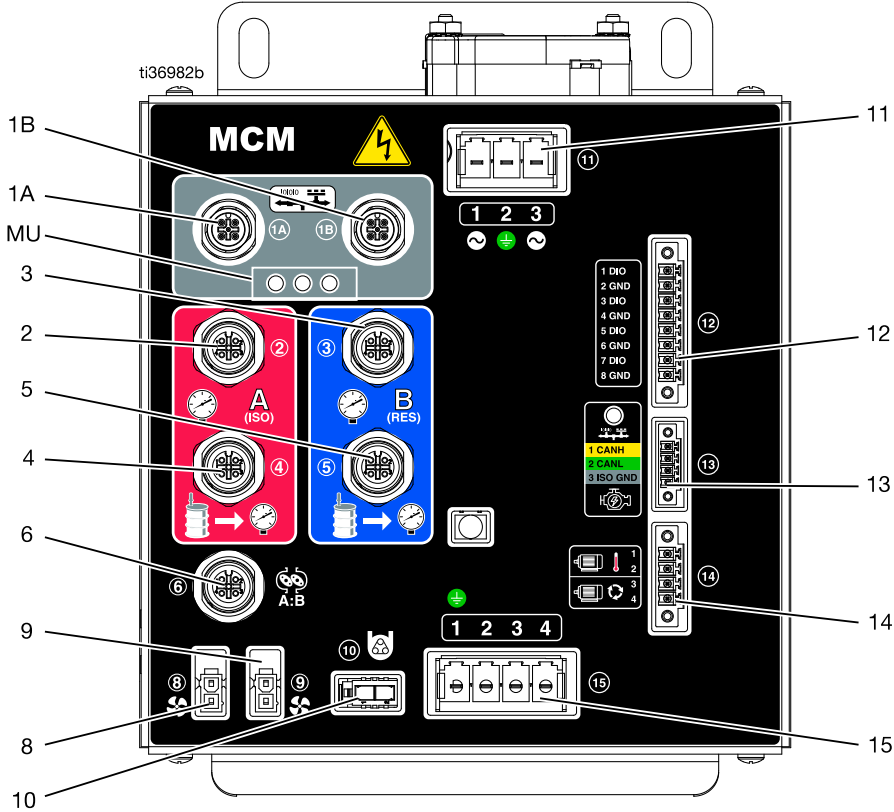

Ref.	Description	Ref.	Description
1A	CAN Communication Connections	9	Motor Fan
1B		10	ISO Lube Pump Output
2	A-Side Pump Outlet Pressure	11	Main Power Input
3	B-Side Pump Outlet Pressure	12	Digital Inputs/Outputs
4	A-Side Pump Inlet Pressure	13	Engine J1939 CAN Connection
5	B-Side Pump Inlet Pressure	14	Motor Temperature and Cycle Switch
6	Flow Meter Inputs	15	Motor Output
8	Transformer Fan	MU	MCM LED Status Lights

Installation

Location

For ease of operation and maintenance, ensure there is adequate lighting in the area the Reactor is installed for visibility and safety.

For ease of operation and maintenance, ensure there is adequate space to the front and sides of the Reactor to access valves or use wrenches and tools.

Tools Required for Installation

9/16 in. socket or wrench

Assemble the Proportioner

Reactor proportioners arrive in a shipping configuration. Before mounting the system, assemble the proportioner in the upright position.

1. Remove the enclosure pivot arm screws (ES).
2. Lift the electrical enclosure (EE).

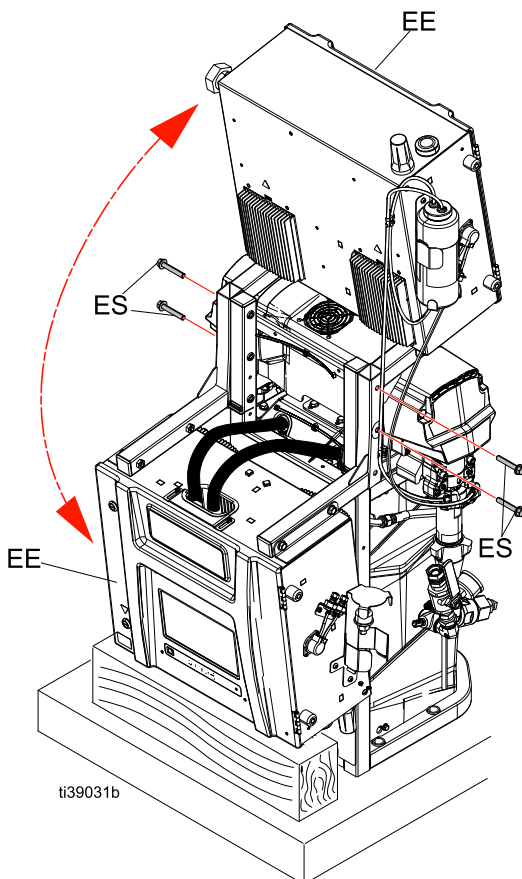

3. Place the left and right wall mounting brackets (MB) as shown in Fig. 4. Insert the enclosure pivot arm screws (ES) through the brackets (MB) and tighten to secure the enclosure.

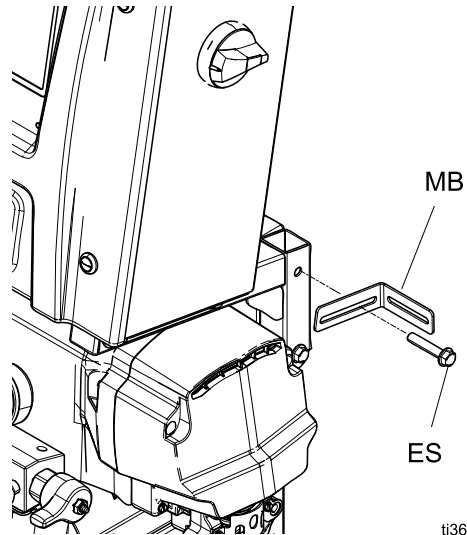



Figure 4 Install Wall Mounting Brackets

Mount the System

				
<p>To prevent serious injury due to the system tipping over, ensure that the Reactor is properly secured to the wall.</p>				

NOTE: Mounting brackets and bolts are included in the box of loose parts shipped with the system.

1. Secure the left and right wall mounting brackets (MB) to the wall. If the brackets do not line up with the wall stud spacing, bolt a piece of wood to the studs then secure the brackets to the wood.

2. Use the four holes in the base of the system frame (BH) to secure the base to the floor. The bolts are not supplied.

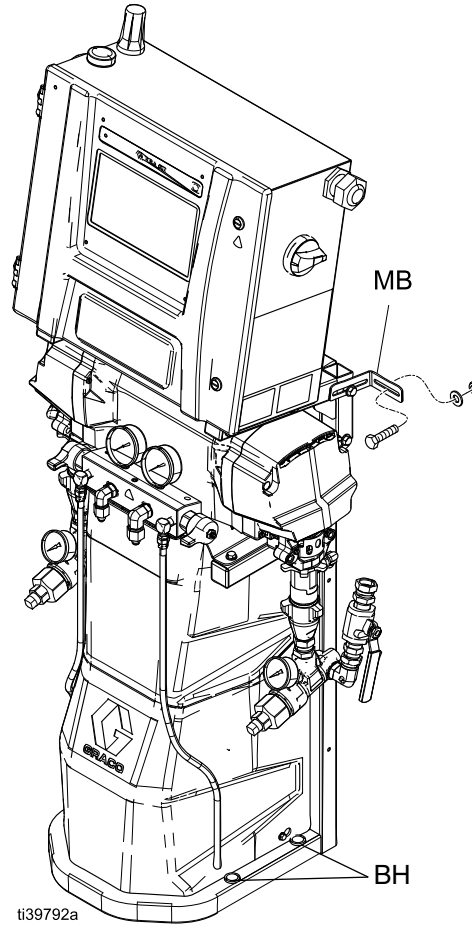

ti39792a

Setup

Grounding

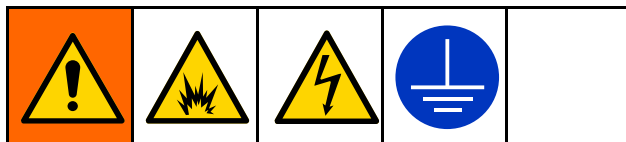

The equipment must be grounded to reduce the risk of static sparking and electric shock. Electric or static sparking can cause fumes to ignite or explode. Grounding provides an escape wire for the electric current.

- **Reactor:** system is grounded through the power cord.
- **Hose:** use only Reactor 3 hoses to ensure static ground continuity. Check electrical resistance of hoses from the gun to the Reactor system ground. If total resistance exceeds 29 mega Ohms, replace hose(s) immediately.
- **Spray gun:** spray gun is grounded through Reactor 3 hoses. Use only Reactor 3 heated hoses.
- **Fluid supply containers:** follow your local code.
- **Object being sprayed:** follow your local code.
- **Solvent pails used when flushing:** follow your local code. Use only metal pails, which are conductive, placed on a grounded surface. Do not place pail on a nonconductive surface, such as paper or cardboard, which interrupts grounding continuity.
- **To maintain grounding continuity when flushing or relieving pressure:** hold a metal part of spray gun firmly to the side of a grounded *metal* pail, then trigger gun.

Tools Required for Setup

- 1.25 in. wrench
- 1 1/16 in. wrench
- 7/8 in. or 22 mm wrench
- 5.8 in. wrench
- 1 in. wrench
- 11/16 in. wrench
- 3/4 in. or 19 mm wrench
- 3/8 in. socket
- Flat-head screwdriver
- 18 in. adjustable wrench

General Equipment Guidelines



NOTICE

Failure to properly size the generator may result in damage. To avoid damage to the equipment, follow the guidelines listed below.

- Determine the correct size generator. Using the correct size generator and proper air compressor will enable the proportioner to run at a nearly constant RPM. Failure to do so will cause voltage fluctuations that can damage electrical equipment. To determine the correct size generator:
 1. List peak wattage requirements of all system components.
 2. Add the wattage required by the system components.
 3. Perform the following equation:

$$\text{Total watts} \times 1.25 = \text{kVA}$$
 (kilovolt-ampères)
 4. Select a generator size that is equal to or greater than the determined kVA.
- Size the proportioner power cord using the electrical ratings in [Models, page 4](#). Failure to do so will cause voltage fluctuations that can damage electrical equipment.
- Use an air compressor with continuous run head unloading devices. Direct online air compressors that start and stop during a job will cause voltage fluctuations that can damage electrical equipment.
- Maintain and inspect the generator, air compressor, and other equipment per the manufacturer recommendations to avoid an unexpected shutdown. Unexpected equipment shutdown will cause voltage fluctuations that can damage electrical equipment.
- Use a wall power supply with enough current to meet system requirements. Failure to do so will cause voltage fluctuations that can damage electrical equipment.

Connect Power

				
<p>All electrical wiring must be done by a qualified electrician and comply with all local codes and regulations.</p>				

1. Turn the main power switch (MP) OFF.
2. Open the electrical enclosure door.

NOTE: The terminal jumpers are located inside the electrical enclosure door.
3. Install the supplied terminal jumpers in the positions shown in the image for the power source used.

NOTE: Ensure the terminal jumpers are fully inserted and lay flush.
4. Route the power cable through the strain relief (EC) in electrical enclosure.
5. Connect the incoming power wires and ground wire as shown in the image. Gently pull on all connections to verify they are properly secured.
6. Verify that all items are connected properly as shown in the image then close the electrical enclosure door.

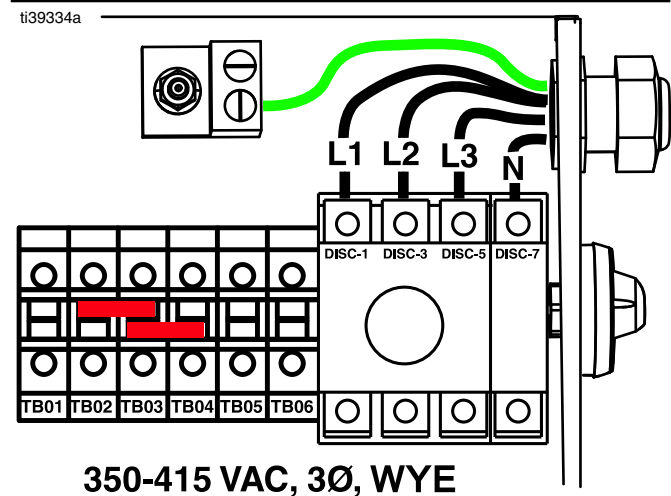
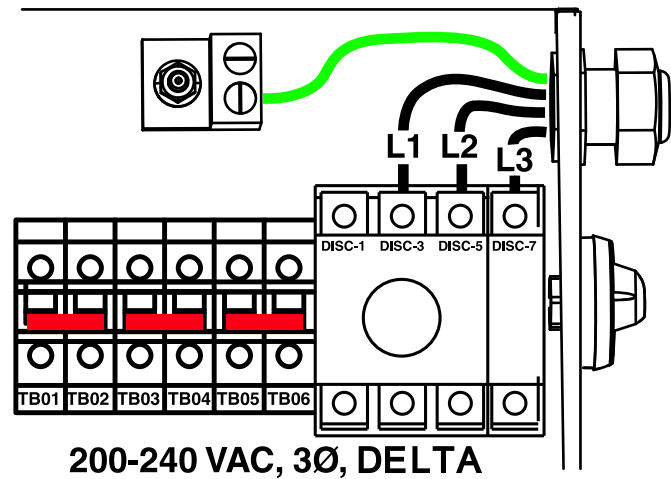
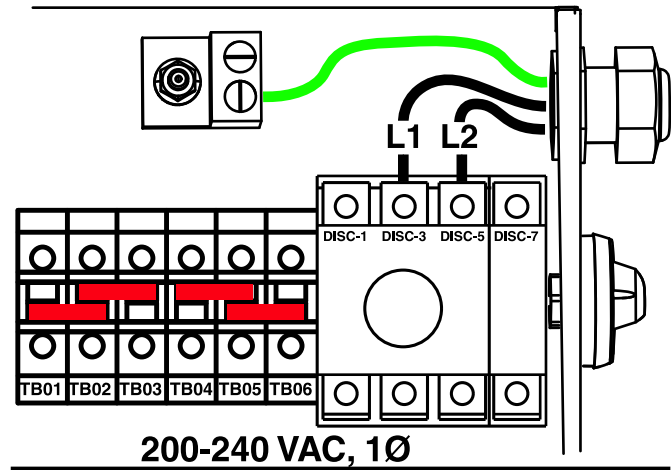

Install Cell Module

NOTE: Installation of the cell module is required to use the Reactor Connect app.

NOTE: The cell module is an optional accessory, and is included with Reactor Pro and Elite models.

1. Turn the main power switch (MP) OFF. Disconnect incoming power at the source.
2. Open the electrical enclosure door.
3. Remove the cardboard insert from the cell module mounting location.

NOTE: Removal of the cardboard insert acknowledges the understanding of the Reactor Owner's Manual, Reactor Connect app Terms and Conditions, and Reactor Connect Privacy Notice.

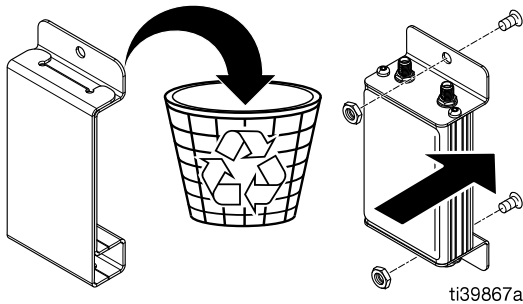

4. Install the cellular module in the cell module mounting location using the supplied nuts.

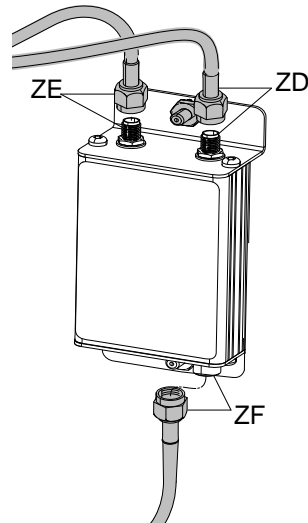

5. Attach the cellular antenna cable (ZE) to the cellular module. Tighten by hand.
6. Attach the GPS antenna cable (ZD) to the cellular module. Tighten by hand.
7. Attach the serial communication cable (ZF) from the ADM (G) to the cellular module.
8. Close and lock the electrical enclosure door with the door latches.



Supply Wet Cups With Throat Seal Liquid (TSL®)

				
<p>The pump rod and connecting rod move during operation. Moving parts can cause serious injury such as pinching or amputation. Keep hands and fingers away from the wet-cup during operation.</p> <p>To prevent the pump from moving, turn the main power switch (MP) OFF.</p>				

NOTE: Replacement TSL bottles can be ordered as follows:

Replacement Part	Description
25T777	Single replacement bottle of TSL
25T859	Six-pack of replacement bottles of TSL

- Component A (ISO) Pump:** Keep ISO Lubrication Reservoir (TS) 3/4 full with Graco Throat Seal Liquid (TSL). The reservoir comes from the factory 3/4 full with TSL. Use a marker to mark the fill line on the reservoir bottle. If the reservoir is low or empty, add new TSL to the fill line. When ordering pre-filled bottles from Graco, use a marker to draw a line at the top of the fluid line as it was shipped. Replace TSL if the fluid develops a gel-like consistency.

The lubrication pump (PP) circulates TSL through the wet cup to wash isocyanate film from the displacement rod.

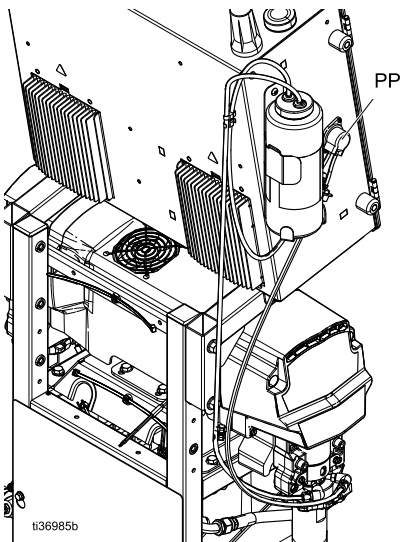

- Component B (Resin) Pump:** Check felt washers in packing nut/wet-cup (S) daily. Keep saturated with Graco Throat Seal Liquid (TSL), to prevent material from hardening on displacement rod.

Replace felt washers when worn or contaminated with hardened material. See your displacement pump manual for further instructions, [Related Manuals, page 3](#).

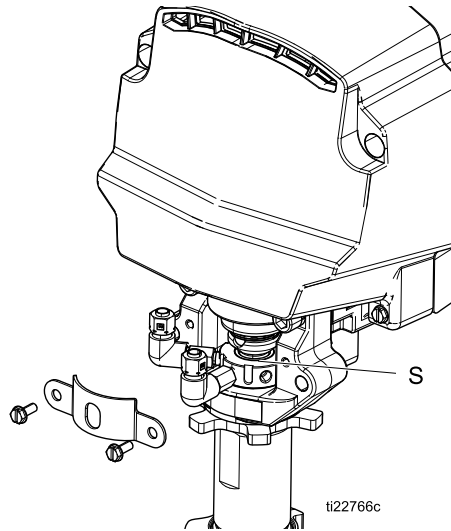

Connect Heated Hose to Proportioner

NOTICE

To avoid damage to the hose, only connect Reactor 3 heated hoses to your Reactor proportioner.

Connect the hose-side power connectors (HB) to the machine-side power connectors (HA). Refer to your heated hose manual for detailed instructions, [Related Manuals, page 3](#).

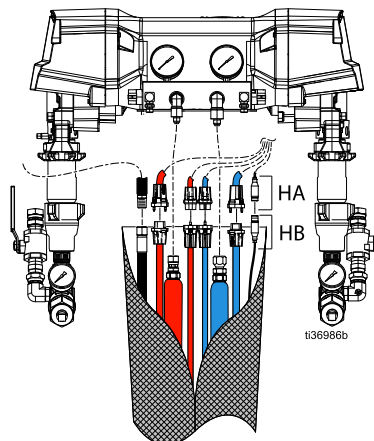

Startup



NOTICE

Proper system setup, startup, and shutdown procedures are critical to electrical equipment reliability. The following procedures ensure steady voltage. Failure to follow these procedures will cause voltage fluctuations that can damage electrical equipment.

1. Follow the [Pressure Relief Procedure](#), page 32.
2. Check the fluid inlet filter screens.

Before daily startup, ensure that the fluid inlet screens are clean. See [Flush Inlet Strainer Screen](#), page 52.

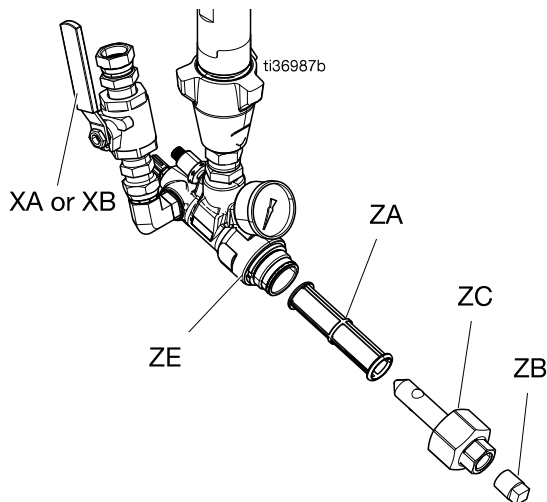

3. Check the ISO Lubrication Reservoir (TS).
Check level and condition of ISO lube daily. See [Pump Lubrication System](#).

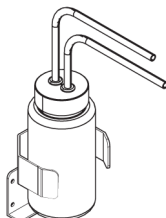

4. Use A and B Drum Level Sticks (24M174) to measure the material level in each drum. If desired, the level can be entered and tracked with the ADM.
5. Check the generator fuel level.

NOTICE

Running out of fuel will cause voltage fluctuations that can damage electrical equipment. Do not run out of fuel.

6. Confirm the system main power switch (MP) is OFF before starting generator.

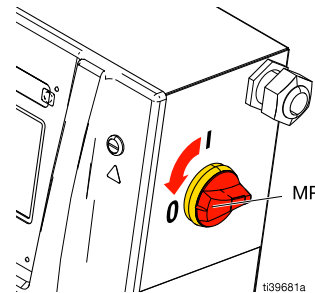

7. Ensure the main breaker on the generator is in the OFF position.
8. Start the generator. Allow the generator to reach full operating temperature.
9. Turn the generator main breaker to the ON position.
10. Turn the system main power switch (MP) ON.

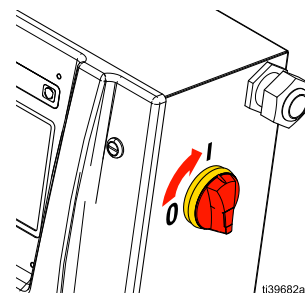

Startup

11. Turn on the air compressor, air dryer, and breathing air (if applicable).

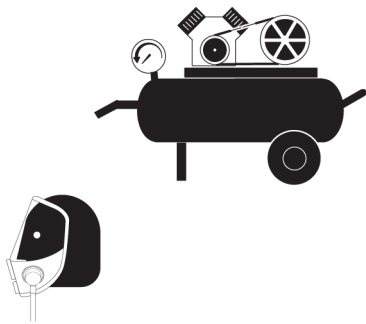

12. For the first startup of new system, use the transfer pumps to supply fluid to the system.

- a. Check that all **Setup** steps are complete. See [Setup, page 25](#).
- b. **If an agitator is used**, turn the agitator on. See your agitator manual, [Related Manuals, page 3](#).
- c. **If you need to circulate fluid through the system** to preheat the drum supply, see [Circulation Through Reactor, page 36](#).

If you need to circulate material through the heated hose to the gun manifold, see [Circulation Through Gun Manifold, page 37](#).

- d. Turn both pressure relief/spray valves

(SA, SB) to spray .

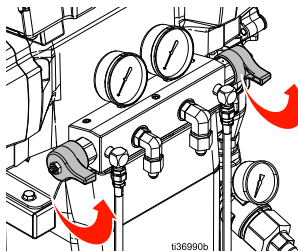

- e. Open the fluid inlet valves (XA and XB). Check for leaks.

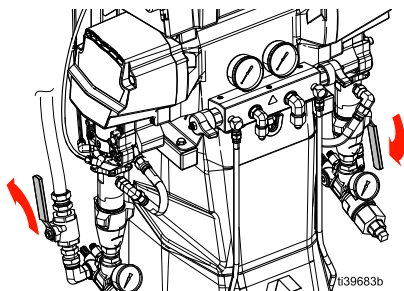

Cross-contamination can result in cured material in fluid lines which could cause serious injury or damage equipment. To prevent cross-contamination:

- Never interchange component A and component B wetted parts.
- Never use solvent on one side if it has been contaminated from the other side.
- Always provide two grounded waste containers to keep component A and component B fluids separate.

- f. Turn on the transfer pumps.
If you are using an electric transfer



pump: on the ADM screen, tap to turn on the A-side transfer pump and



to turn on the B-side transfer pump.

If you are using a pneumatic transfer pump: see your pump manual, [Related Manuals, page 3](#).

- g. Hold the gun fluid manifold over two grounded waste containers. Open fluid valves A and B until clean, air-free fluid comes from valves. Close valves.

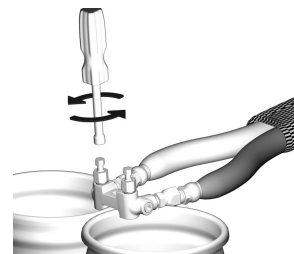

The Fusion AP gun manifold is shown.

- h. Turn off the transfer pumps.
If you are using an electric transfer

pump: tap  to turn off the

A-side transfer pump and  to



turn off the B-side transfer pump.



If you are using a pneumatic transfer pump: see your pump manual, [Related Manuals, page 3](#).

13. Preheat the system:

NOTE: The hose calibration must be completed before turning on the hose heat for the first time. See [Calibrate the Heated Hose, page 38](#).

- a. Tap  to turn on the hose heat.



			
<p>This equipment is used with heated fluid which can cause equipment surfaces to become very hot. To avoid severe burns:</p> <ul style="list-style-type: none"> • Do not touch hot fluid or equipment. • Do not turn on hose heat without fluid in hoses. • Allow equipment to cool completely before touching it. • Wear gloves if fluid temperature exceeds 110°F (43°C). 			

			
<p>Thermal expansion can cause overpressurization, resulting in equipment rupture and serious injury, including fluid injection. Do not pressurize system when preheating hose.</p>			

- b. **If you need to circulate fluid through the system to preheat the drum supply,** see [Circulation Through Reactor, page 36](#). **If you need to circulate material through the heat hose to the gun manifold,** see [Circulation Through Gun Manifold, page 37](#).

- c. Wait for the hose to reach set point temperature.

NOTE: Hose heat-up time may increase at voltages less than 230 VAC when maximum hose length is used.

- d. Tap  to turn on the ISO heat zone and  to turn on the RES heat zone.

Operation

Pressure Relief Procedure



Follow the Pressure Relief Procedure whenever you see this symbol.

This equipment stays pressurized until pressure is manually relieved. To help prevent serious injury from pressurized fluid, such as skin injection, splashing fluid and moving parts, follow the Pressure Relief Procedure when you stop spraying and before cleaning, checking, or servicing equipment.



1. Tap to turn off the motor.

NOTE: Electric transfer pumps will automatically turn off with the motor.



2. Tap , , and to turn off all heat zones.

3. Relieve pressure in the gun and perform the gun shutdown procedure. See your gun manual, [Related Manuals, page 3](#).

4. Engage the gun piston safety lock.

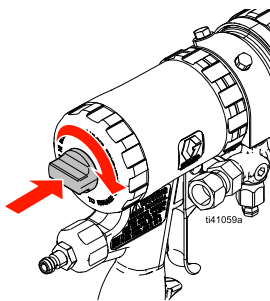

The Fusion AP gun is shown.

5. Close the gun fluid inlet valves A and B.

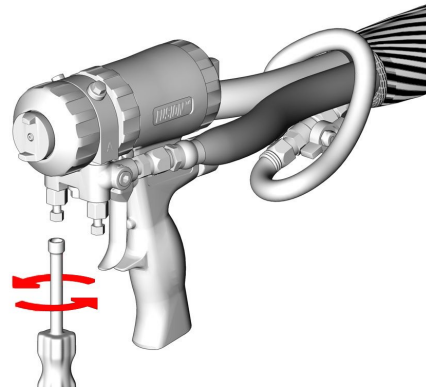

The Fusion AP gun is shown.

6. Shut off the transfer pumps and agitator, if used.

For pneumatic transfer pumps and agitators, refer to your component manuals. See [Related Manuals, page 3](#).

For electric transfer pumps (if necessary),



tap to turn off the A-side



transfer pump power, and to turn off the B-side transfer pump power.

7. Make sure the bleed or circulation lines are connected and routed to waste containers or supply tanks. Turn the pressure relief/spray valves (SA, SB) to pressure relief/circulation



. Make sure the gauges drop to 0.

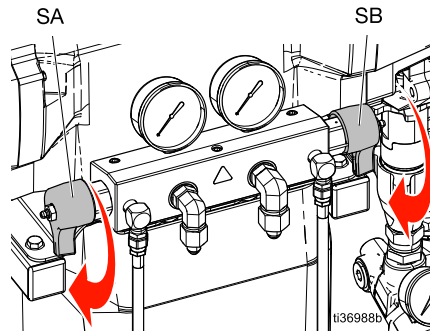

Jog Mode

Jog mode has two purposes:

- To speed fluid heating during circulation
- To ease system flushing and priming

Jog Level

The jog level determines how quickly the system will pass chemicals through the system. Jog levels are between J1 and J20. Lower jog levels will move fluid at lower speeds and pressures. Higher jog levels move fluid at higher speeds and pressures. Actual speed and pressure are variable based on the chemicals used.

Jog the System

NOTE: If **pneumatic transfer pumps** are in use, manually turn on air to the pumps. See your pump manual, [Related Manuals, page 3](#) .
If **electric transfer pumps** are in use, the pumps automatically turn on when the motor is turned on.



1. Tap the **Pump Mode** button
2. Select **Jog** mode from the drop down menu.

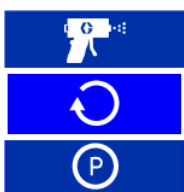

3. Tap  to set the jog level.

4. Tap  to start the motor.

5. Tap  to stop the motor.



Jog the Transfer Pumps Separately

Pneumatic Transfer Pumps: Manually turn on/off air to the pumps one at a time. See your pump manual, [Related Manuals, page 3](#) .



Electric Transfer Pumps:



1. Ensure the motor power  is off.

2. Tap  to turn on the A-side transfer pump. Tap  to set the jog level.

3. Tap  to turn off the A-side transfer pump.

4. Tap  to turn on the B-side transfer pump. Tap  to set the jog level .

5. Tap  to turn off the B-side transfer pump.

Jog Limit Feature

This feature automatically shuts off the Reactor motor after a specified number of jog cycles.



Tap the check box next to the  icon to enable/disable this feature. When enabled, the job cycle limit will display and decrement while the motor is running in jog mode.

The jog cycle limit can be set on the Pressure/Flow Setup Screen.

Purge Air Procedure



NOTE: Perform this procedure any time air is introduced into the system.

1. Follow the [Pressure Relief Procedure, page 32](#).
2. Install a recirculation kit or install bleed lines between the outlet manifold recirculation fitting and a waste container.

NOTICE

To prevent equipment damage, do not circulate fluid containing a blowing agent without consulting with your material supplier regarding fluid temperature limits.

3. **If using pneumatic transfer pumps,** turn on air to the transfer pumps. See your pump manual, [Related Manuals, page 3](#).



4. Tap the pump mode button
5. Select Jog mode from the drop down menu.

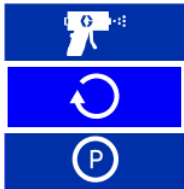

6. Tap **J1** to set the jog level to desired setting. See [Jog Mode, page 33](#).



7. Tap the power button to turn on the motor.

NOTE: Electric transfer pumps will automatically turn on with the motor.

8. Pump one gallon (3.8 L) of material through the system.
9. Set the pressure relief/spray valves (SA, SB)

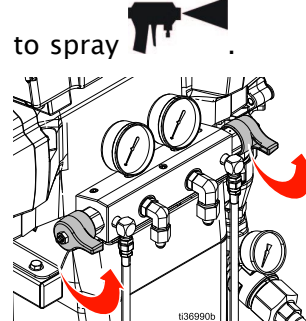

10. **If using pneumatic transfer pumps,** turn off air to the transfer pumps. See your pump manual, [Related Manuals, page 3](#).



11. Tap the power button to turn off the motor.

NOTE: Electric transfer pumps will automatically turn off with the motor.

12. Set the pressure relief/spray valves (SA, SB)

to pressure relief/circulation 

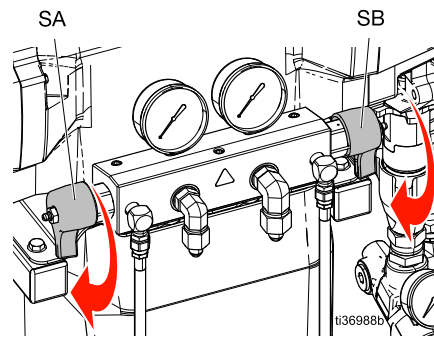

13. Listen for a “spitting” sound from the bleed lines (N) or recirculation lines (R). See [Typical Installation, page 15](#). This sound indicates that the Reactor system still contains unwanted air. If the system still contains air, repeat the purge air procedure.

Flush the Equipment

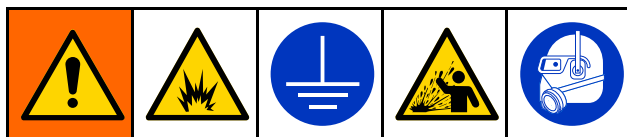

To help prevent fire and explosion:

- Flush equipment only in a well-ventilated area.
- Do not spray flammable fluids.
- Do not turn on heaters while flushing with flammable solvents.
- Always ground equipment and waste container.
- Flush out old fluid with new fluid, or flush out old fluid with a compatible solvent before introducing new fluid.
- Use the lowest possible pressure when flushing.
- All wetted parts are compatible with common solvents. Use only moisture-free solvents.

To the flush feed hoses, pumps, heaters, hose, and the gun manifold:

1. Install bleed lines between the outlet manifold recirculation fitting and a grounded metal waste container.
2. Route the circulation lines back to respective A or B supply, or grounded metal waste containers.
3. Set the pressure relief/spray valves (SA, SB)

to pressure relief/circulation .

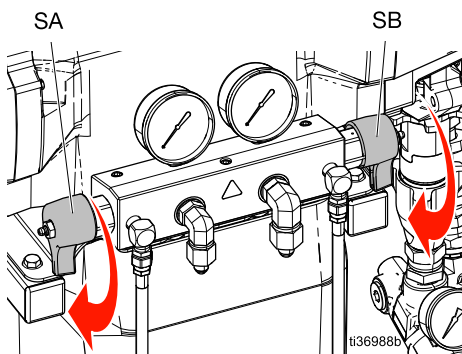

4. Use jog mode to circulate fluid. Reactor systems allow the entire system to be in jog mode, or A and B-side transfer pumps to be put into jog mode separately. See [Jog Mode, page 33](#). Circulate fluid until only solvent comes from the bleed lines. The Reactor feed hoses, pumps, and heaters are now flushed.
5. Set the pressure relief/spray valves (SA, SB) to spray

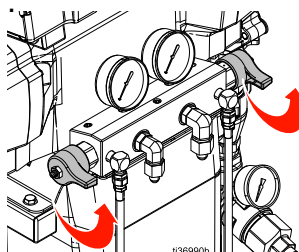

6. Hold the gun fluid manifold over two grounded waste containers. Open fluid valves XA and XB (see [Component Identification, page 18](#)) until only solvent comes from the valves. Close the valves. The Reactor hose and gun manifold are now flushed.
NOTE: For the estimated number of machine cycles needed to flush different models and hose configurations, see the table on the following page.
7. **Optional:** Use accessory circulation kit to circulate fluid through the gun manifold.

Circulation	Gun	Manual in English
246362	Fusion AP, PC, MP	309818
256566	Fusion CS	313058

NOTICE

To prevent moisture from reacting with isocyanate, always leave the system filled with a moisture-free plasticizer or oil. Do not use water. Never leave the system dry. See [Important Isocyanate Information, page 13](#).

Fluid Circulation

Circulation Through Reactor

NOTICE
To prevent equipment damage, do not circulate fluid containing a blowing agent without consulting with your material supplier regarding fluid temperature limits.

NOTE: Optimum heat transfer is achieved at lower fluid flow rates with temperature set points at desired drum temperature. To circulate through gun manifold and preheat hose, see [Circulation Through Gun Manifold, page 37](#).

1. Route the circulation lines back to respective component A or B supply drum. See [Typical Installation with system fluid manifold to drum circulation, page 16](#). Use hoses rated at the maximum working pressure of this equipment. See [Technical Specifications, page 58](#).
2. Follow [Startup, page 29](#).



To avoid injection injury and splashing, do not install shutoffs downstream of the PRESSURE RELIEF/SPRAY valve outlets (BA, BB). The valves function as overpressure relief valves when set to SPRAY. Lines must be open so valves can automatically relieve pressure when machine is operating.

3. Set the pressure relief/spray valves (SA, SB) to pressure relief/circulation

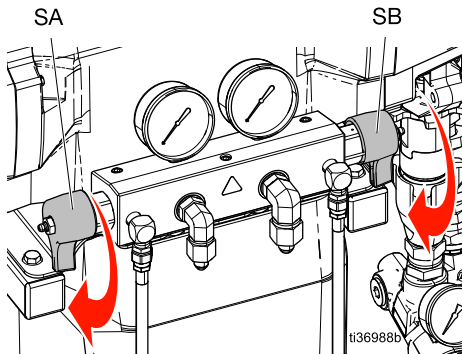

4. Tap +/- to set the temperature targets

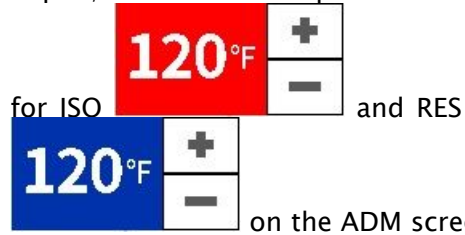

5. Use jog mode to circulate fluid until the desired drum temperature for ISO and RES temperatures reach their respective targets. Reactor systems allow the entire system to be in jog mode, or A and B-side transfer pumps to be put into jog mode separately. See [Jog Mode, page 33](#).

6. Tap to turn on the ISO heat zone, and tap to turn on the RES heat zone.

7. Tap to turn on the hose heat
8. Set the temperature targets for the desired spray temperature of ISO and RES. Wait until the fluid temperature readings reach their set temperature targets.

9. Tap the **Pump Mode** button
10. Select **Spray** mode from the drop down menu.

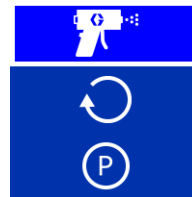

11. Set the pressure relief/spray valves (SA, SB) to spray

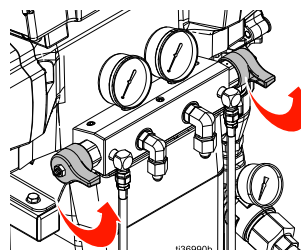

Circulation Through Gun Manifold

NOTICE

To prevent equipment damage, do not circulate fluid containing a blowing agent without consulting with your material supplier regarding fluid temperature limits.

NOTE: Optimum heat transfer is achieved at lower fluid flow rates with temperature set points at desired drum temperature. Circulating fluid through the gun manifold allows rapid preheating of the hose.

1. Install the gun manifold (E) on an accessory circulation block (CK).

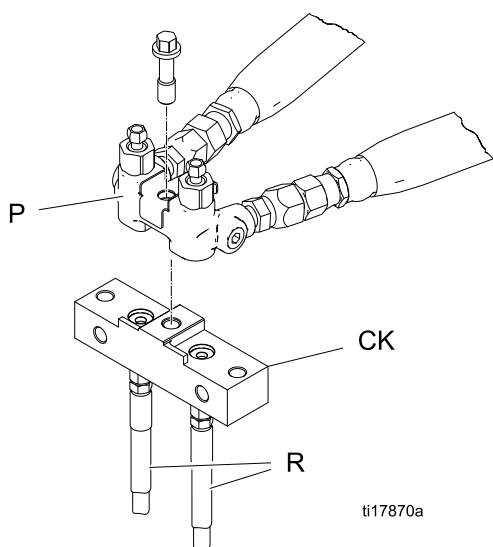

The Fusion AP gun manifold is shown.

Circulation	Gun	Manual in English
246362	Fusion AP, PC, MP	309818
256566	Fusion CS	313058



2. Route the circulation lines back to their respective component A or B supply drum. See [Typical Installation with gun fluid manifold to drum circulation](#), page 17. Use hoses rated at the maximum working pressure of this equipment. See [Technical Specifications](#), page 58.

3. Follow [Startup](#), page 29.

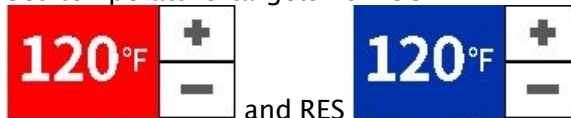
4. Set temperature targets for ISO



on the ADM screen.

5. Tap  to turn on the ISO primary heat zone and  to turn on the RES primary heat zone.

6. Use jog mode to circulate fluid until ISO and RES temperatures reach their respective targets. Reactor systems allow the entire system to be in jog mode, or A and B-side transfer pumps to be put into jog mode separately. See [Jog Mode](#), page 33.

7. Tap  to turn on the hose heat.



8. Tap the **Pump Mode** button
9. Select **Spray** mode from the drop down menu.

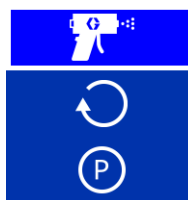

10. Set the pressure relief/spray valves (SA, SB)

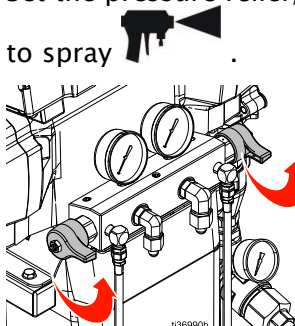

Calibration

Calibrate the Heated Hose

NOTICE



To prevent damage to the heated hose, a hose calibration is required if any of the following conditions are true:

- The hose has never been calibrated before.
- A section of hose has been replaced.
- A section of hose has been added.
- A section of hose has been removed.



NOTE: The Reactor and heated hose must be at the same ambient temperature to get the most accurate calibration.

NOTE:

A minimum of 50 ft (15.2 m) hose is required for proper operation while in Resistance Control Mode.

1. Tap . Go to **Setup > Heat**.
2. Tap **Calibrate** .
3. Tap **Continue**  to acknowledge the reminder to have the hose at ambient conditions.
4. Wait while the system measures the hose resistance.

NOTE: If hose heat was on prior to the calibration procedure, the system will wait up to five minutes to allow the wire temperature to equalize.

5. Tap **Accept**  to proceed with the calibration, or **Cancel**  to stop the calibration.

NOTE: A temperature estimate will be displayed if the system was able to measure the hose wire resistance.

Calibrate the Transfer Pumps

After installing a new electric transfer pump, you must calibrate the transfer pump motor.

1. Tap . Go to **Setup > Supply System**.
2. If the transfer pump type is set to **Electric**, change the transfer pump type to **Air**. Tap the **Transfer Pump (A or B) Type** field. Select **Air**.
3. Change the transfer pump type from **Air** to **Electric**. Tap the **Transfer Pump (A or B) Type** field. Select **Electric**.

NOTE: Changing the transfer pump type from **Air** to **Electric** triggers the calibration function.

4. **If calibrating both transfer pumps**, repeat steps 2-3 for the other transfer pump motor.
5. Confirm there is no or low inlet pressure in the transfer pump by opening the recirculation lines (R).
6. Turn on the transfer pumps. The transfer pumps will slowly move for multiple strokes and then shift into normal operation.
 - a. To turn on the transfer pumps

individually: Tap  to turn on the A-side transfer pump or tap

 to turn on the B-side transfer pump.

- b. To turn on both transfer pumps with

the system: Tap  to turn on the motor. Electric transfer pumps will automatically turn on with the motor.

Spray

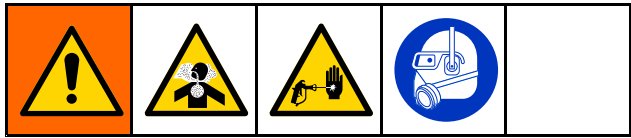

1. Engage the gun piston safety lock and close gun fluid inlet valves A and B.



Fusion

Probler

2. Attach the gun fluid manifold. Connect the gun air line. Open the air line valve.

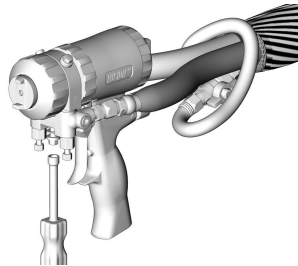

3. Adjust the gun air regulator to desired gun air pressure. Do not exceed the maximum rated air pressure. See your gun manual, [Related Manuals, page 3](#).
4. Set the pressure relief/spray valves (SA, SB)

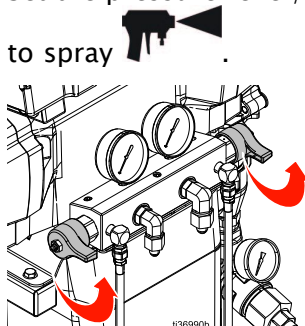

5. Verify the heat zones are on and temperatures are on target.

6. Open the fluid inlet valve located at each pump inlet.

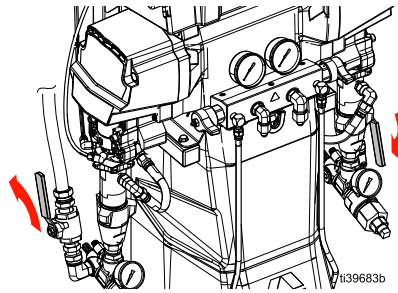

7. Tap the **Pump Mode** button
8. Select **Spray** mode from the drop down menu.

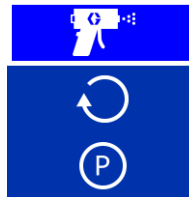

9. **If using pneumatic transfer pumps**, turn on air to the transfer pumps. See your pump manual, [Related Manuals, page 3](#).

10. Tap  to turn on the motor.

NOTE: Electric transfer pumps will automatically turn on with the motor.

11. Check the fluid pressure gauges (GA, GB) to ensure proper pressure balance. If imbalanced, reduce pressure of higher component by slightly turning the pressure relief/spray valve for that component toward

pressure relief/circulation  until the gauges show balanced pressures.

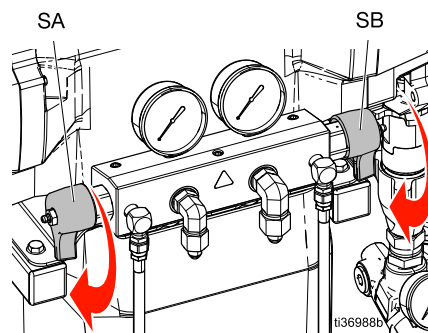

Operation

12. Open the A and B gun fluid valves.

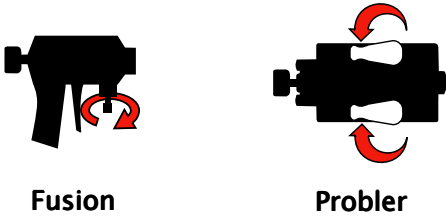

Fusion

Probler

NOTICE

To prevent material crossover on impingement guns, never open fluid manifold valves or trigger gun if pressures are imbalanced.

13. Disengage the gun piston safety lock.

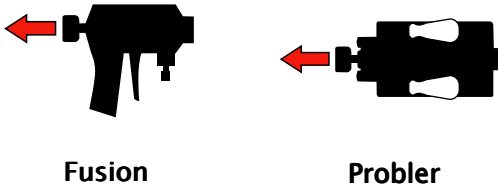

Fusion

Probler

14. Pull the gun trigger to test spray onto cardboard. If necessary, adjust pressure and temperature to get desired results.

Spray Adjustments

Flow rate, atomization, and amount of overspray are affected by four variables:

- **Fluid pressure setting.** Too little pressure results in an uneven pattern, coarse droplet size, low flow, and poor mixing. Too much pressure results in excessive overspray, high flow rates, difficult control, and excessive wear.
- **Fluid temperature.** Similar effects to fluid pressure setting. The A and B temperatures can be offset to help balance the fluid pressure.
- **Mix chamber size.** Choice of mix chamber is based on desired flow rate and fluid viscosity.
- **Clean-off air adjustment.** Too little clean-off air results in droplets building up on the front of the nozzle, and no pattern containment to control overspray. Too much clean-off air results in air-assisted atomization and excessive overspray.

Shutdown

NOTICE

Proper system Setup, Startup, and Shutdown procedures are critical to electrical equipment reliability. The following procedures ensure steady voltage. Failure to follow these procedures will cause voltage fluctuations that can damage electrical equipment and void the warranty.

1. If using pneumatic transfer pumps, turn off air pressure to the transfer pumps. See your pump manual, [Related Manuals, page 3](#).

2. Tap  to turn off the motor.

NOTE: Electric transfer pumps will automatically turn off with the motor.

3. Tap , , and  to turn off all heat zones.
4. Follow the [Pressure Relief Procedure, page 32](#).

5. Tap the Pump Mode button .
6. Select the Park mode icon from the drop down menu.

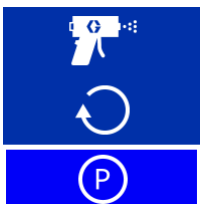

The park icon will flash red while the park operation is in progress. The park operation is complete when the motor and transfer pumps are off, and a green check appears next to the Park pump mode icon

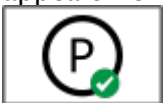

Verify the Park operation is complete before moving to the next step.

NOTE: Pressure relief valves must be set to pressure relief/circulation to complete park operation.

NOTE: Electric transfer pumps will automatically park at the bottom of their stroke when the system is in Park mode.

7. Turn off the air compressor, air dryer, and breathing air.

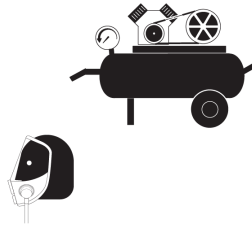

8. Turn the main power switch (MP) OFF.

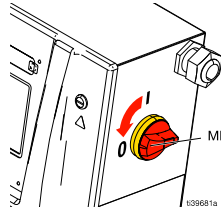

9. Close all fluid supply valves.

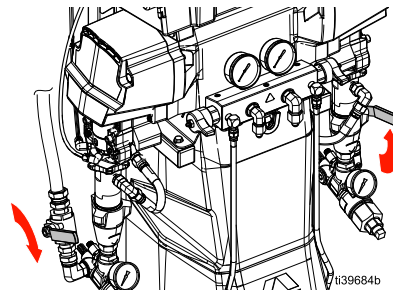

10. Set the pressure relief/spray valves (SA, SB)

to spray  to seal out moisture from the drain line.

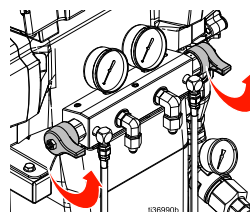

11. Engage the gun safety lock then close fluid manifold valves A and B.

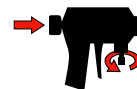

Fusion

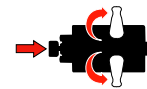

Probler

Advance Display Module (ADM)

Menu Bar

The menu bar is located at the top of each screen of the ADM. The menu bar contains the **Navigation** menu (1), current screen (2), system notifications (3), and time (4).



System Notification Icons

Icon	Name	Description
	Connected to Server	The cell module detected and connected to network and server.
	Connected to Network, but not to Server	The cell module detected and connected to network, but unable to connect to server.
	Not Connected to Network	The cell module detected, but unable to connect to the network.
	GPS Location Tracking	GPS location tracking is able to determine system's location.

	Software Update Pending	A software update will occur on next power cycle.
	USB Download/Upload In Progress	The USB drive detected and download/upload is in progress.
	USB Download/Upload Complete	The USB drive detected and download/upload has completed successfully.
	USB Error	The USB drive detected but an error is preventing it from being used.

Navigate the Screens

To navigate between screens, tap , then select the desired location from the drop-down.

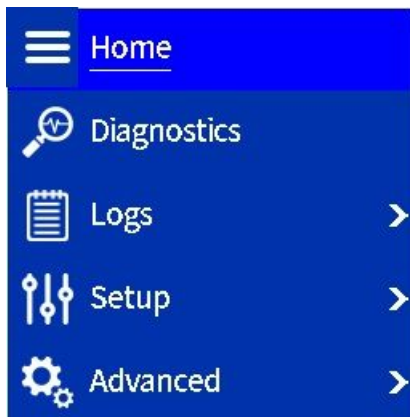

To switch between pages within each screen, tap and .

Home Screen

Use the Home screen to control the Reactor system operation functions.

Temperature Control Panel

The Temperature Control panel contains controls for Hose heat and A and B-side Primary heaters.

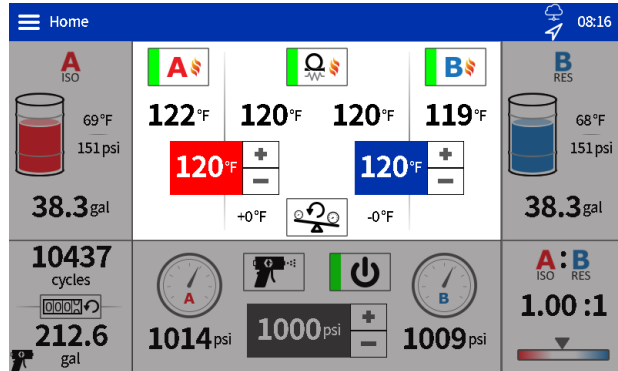

Icon	Name	Description
	Primary Heater A On/Off	Tap to toggle the A primary heater state.
	Primary Heater B On/Off	Tap to toggle the B primary heater state.
	Hose Heat On/Off	Tap to toggle the hose heat state.
	A (ISO) Temperature Setpoint	Tap +/- to adjust the setpoint by one degree. Press and hold +/- to rapidly adjust the setpoint. Tap the number to open a pop-up and type in the setpoint directly.
	B (RES) Temperature Setpoint	Tap +/- to adjust the setpoint by one degree. Press and hold +/- to rapidly adjust the setpoint. Tap the number to open a pop-up and type in the setpoint directly.
	Hose Current Setpoint	Tap +/- to adjust the setpoint by one amp. Press and hold +/- to rapidly adjust the setpoint. Tap the number to open a pop-up and type in the setpoint directly. NOTE: The Hose Current Setpoint button is only displayed if the Hose Control Mode is set to Manual in the Setup, page 47 settings.
	Reset Auto Pressure Balance Temperature Offsets	Tap to reset the Auto Pressure Balance temperature offset values (to the left and right of this button).

A and B side Supply Control Panels

The A and B Supply Control panels display the remaining material supply for A and B side materials, and contains controls for electric transfer pumps (if applicable).

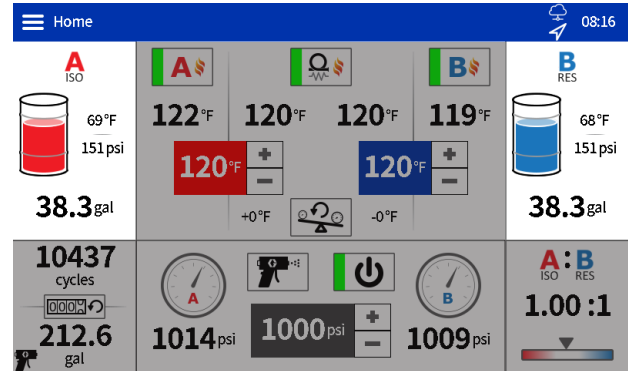

Icon	Name	Description
	Electric Transfer Pump A On/Off	Press to toggle the A electric transfer pump state. NOTE: This button is only displayed if an electric transfer pump is installed and the proportioner pump state is off. The electric transfer pumps are automatically turned on any time the proportioner pump is turned on.
	Electric Transfer Pump B On/Off	Press to toggle the B electric transfer pump state. NOTE: This button is only displayed if an electric transfer pump is installed and the proportioner pump state is off. The electric transfer pumps are automatically turned on any time the proportioner pump is turned on.
	A (ISO) Transfer Pump Jog Level	Tap +/- or the displayed jog level number (i.e. J10) to set the A-side transfer pump jog level. NOTE: Jog levels are between 1 and 20. Jog Mode, page 33 .
	B (RES) Transfer Pump Jog Level	Tap +/- or the displayed jog level number (i.e. J10) to set the B-side transfer pump jog level. NOTE: Jog levels are between 1 and 20. Jog Mode, page 33 .

Cycle Count Panel

The Cycle Count panel contains information regarding pump cycles and the equivalent amount of material.

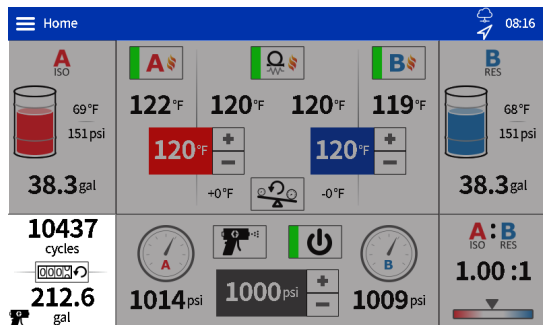

Icon	Name	Description
	Reset Cycle Counter	Tap to reset the cycle and volume counters in the lower left portion of the screen. NOTE: Separate counters are kept in spray and jog mode. Pressing the reset button only resets the currently displayed counters

Ratio Monitoring Panel

The Ratio Monitoring panel displays information regarding the A to B material ratio.

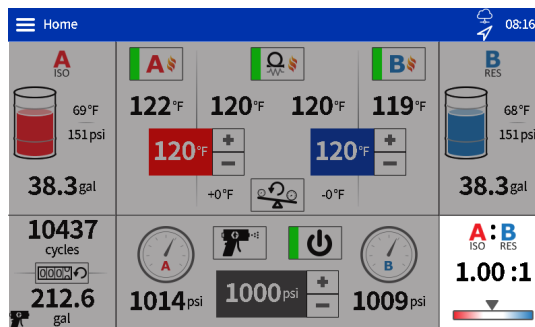

Jog Cycle Limit Panel

The Jog Cycle Limit panel contains a feature enable/disable check box and a cycle limit countdown. Tap the check box to enable the feature. When enabled, the Reactor pump will shut off after the specified number of cycles.

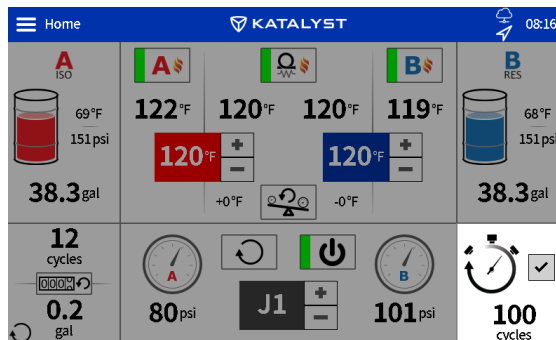

Proportioner Control Panel

This Proportioner Control panel contains controls for operation of the proportioner pump.

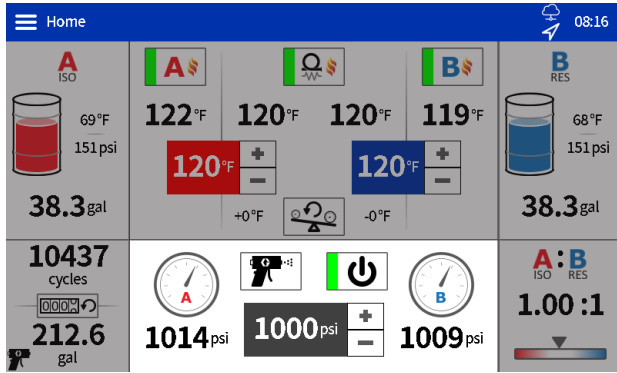

Icon	Name	Description
	Proportioner Pump Pressure Setpoint	Tap +/- to adjust the setpoint by ten psi. Press and hold +/- to slew. Tap the number to open pop-up and type in setpoint directly.
	Proportioner Pump Jog Level	Tap +/- to adjust the jog level by one. Press and hold +/- to slew. Tap the number to open pop-up and type in jog level directly.
	Proportioner Pump Modes	Tap to select the proportioner pump mode. Spray : used to pressurize and spray material. Pump drives to pressure setpoint. Jog : used to recirculate/flush material. Pump drives to jog level. Park : used to park the electric transfer pumps and proportioner pump. Parking is done to increase seal life on the proportioner pump and ease ProConnect for the electric transfer pumps (if present). NOTE : The park operation will start when entering Park mode from any other mode. The park icon will flash red while park operation is in progress. Parked : indicates a park operation has completed successfully.
	Proportioner Pump On/Off	Tap to toggle the proportioner pump state.

Diagnostic Screen

Use the Diagnostic screen to view information for all system components.

Icon	Name	Description
	General System Data	Tap to display general system information related to heat/pressure/flow.
	Heat Data	Tap to display more detailed information related to heat.
	Pressure / Flow Data	Tap to display more detailed information related to pressure / flow.
	Override ISO Lube Pump	Press to force the ISO lube pump to run. NOTE : Button is momentary (must press and hold to run pump).
	Electric Transfer Pump Data	Tap to display more detailed information related to electric transfer pumps. NOTE : This page is only displayed if at least one electric transfer pump is installed on the system.
	Engine Data	Tap to display more detailed information related to engine. NOTE : This page is only displayed if an active connection is present between the MCM port 13 and an engine with a J1939 communication port.

Logs Screens

Use the Logs screens to view information for Reactor operation performance.

Errors

The Errors screen shows the date, time, error code, and description of all errors that have occurred in the system during operation.

Icon	Name	Description
	Help	Tap to display a QR code with a link to help.graco.com for error and troubleshooting information.

Events

The Events screen shows the date, time, event code, and description of all events that have occurred in the Reactor system during operation.

Usage

The Usage screen shows pump cycle counts and material usage for each day of use of the Reactor system.

USB Data Download

1. Turn the main power switch (MP) OFF.
2. Open the electrical enclosure door.
3. Insert the USB drive to the port in the back of the ADM.

NOTE: USB A type drives are supported.

NOTE: The ADM can read/write to FAT (File Allocation Table) formatted storage devices. NTFS (New Technology File System) formatted devices are not supported.

4. Close the electrical enclosure door.
5. Turn the main power switch (MP) ON. The

USB Download in Progress icon  will appear in the menu bar on the ADM screen.

6. Wait for the **USB Download Complete** icon  to appear in the menu bar.
7. Turn the main power switch (MP) OFF.
8. Open the electrical enclosure door.
9. Remove the USB drive.
10. Close the electrical enclosure door.

Setup Screens

Use the Setup screens screens to edit settings for the Reactor system.

Pressure/Flow

Use the Pressure/Flow screen to set pressure monitoring settings for the Reactor system.

Setting	Description
Enable Auto Pressure Balance	<p>This feature monitors the pressure imbalance while material is flowing and adds temperature offsets to the setpoints to minimize the pressure imbalance.</p> <p>Tap the checkbox to enable/disable Auto Pressure Balance. Tap the number value to adjust the temperature offset limit allowed using Auto Pressure Balance.</p> <p>NOTE: This feature is only enabled on Pro and Elite models.</p>
Enable Pressure Imbalance Alarms	<p>Tap the checkbox to enable/disable Pressure Imbalance Alarms. Tap the number value to adjust the alarm threshold.</p> <p>NOTE: Pressure imbalance alarms are automatically enables if flow meters are enabled.</p>
Enable Pressure Imbalance Deviations	<p>Tap the checkbox to enable/disable Pressure Imbalance Deviations. Tap the number value to adjust the deviation threshold.</p>
Enable Reactor Smart Control	<p>Tap the checkbox to enable/disable Reactor Smart Control. This feature does the following:</p> <ul style="list-style-type: none"> • Slows down the proportioner pump if inlet pressure is low. This is done to allow the transfer pumps to keep up and avoid off-ratio conditions. • Controls the output pressure to the average of the A and B pressure sensors (instead of the max).

Enable Flow Meters	Tap the checkbox to enable/disable flow meters.
Enable Flow Meter Alarms	<p>Tap the checkbox to enable/disable flow meter alarms. Tap the number value to adjust the alarm threshold.</p> <p>NOTE: Flow meter alarms are only available when flow meters are installed.</p>
Flow Meter A K-Factor	<p>Tap the number value to enter the K-Factor for the A side flow meter.</p> <p>NOTE: The K-Factor is noted on the meter label.</p>
Flow Meter B K-Factor	<p>Tap the number value to enter the K-Factor for the B side flow meter.</p> <p>NOTE: The K-Factor is noted on the meter label.</p>
Enable Maximum Pressure Setpoint	Tap the checkbox to enable/disable a user defined maximum pressure setpoint. Tap the number to adjust the maximum pressure setpoint that can be entered on the home screen.
Enable Minimum Pressure Setpoint	Tap the checkbox to enable/disable a user defined minimum pressure setpoint. Tap the number to adjust the minimum pressure setpoint that can be entered on the home screen.
Enable Jog Limit	<p>Tap the checkbox to enable/disable the jog limit feature. Tap the number to adjust the jog cycle limit. When enabled and in jog mode, the Reactor pump will automatically shutoff when the specified number of cycles are completed.</p> <p>NOTE: This feature can be enabled directly on the home screen.</p>

Heat

Use the Heat screen to calibrate hose heat and set the hose control mode. To calibrate the system, see the [Calibration, page 38](#).

Setting	Description
Hose Control Mode	<p>Tap to select hose control mode.</p> <p>FTS: control to target temperature using an FTS (fluid temperature sensor) on each side of the hose. Calibration is required to use FTS control mode. See Calibration Procedure, page 38.</p> <p>Resistance: control to target temperature using the resistance of the heater element (changes with temperature). Calibration is required to use Resistance control mode. See Calibration Procedure, page 38.</p> <p>Manual: control to target current (amps) to heat the hose. Manual control mode has no pre-programmed control and is designed to be used for a limited amount of time until a proper calibration can be performed or FTS issues can be resolved.</p> <p>NOTE: When manual hose mode is enabled, the manual hose mode advisory (EVCH) will appear.</p>
Hose A Calibration Factor	Resistance value determined during the calibration process for the A side hose.
Hose B Calibration Factor	Resistance value determined during the calibration process for the B side hose.
Last Calibration Date	Date/time of last successful calibration.

Enable Power Management	<p>Tap the checkbox to enable/disable power management. Tap the number to adjust the primary heater power limit.</p> <p>Power management allows users to limit the primary heater wattage to a desired level. This can be done to free up auxiliary power for other devices on a generator and/or run the system on a smaller generator. With power management enabled, the new total system load can be determined using the formula below:</p> <p>Total System Load (with power management) = Total System Load (without power management) - (Primary Heater Load (without power management) - Primary Heater Load (with power management))</p> <p>Example: Elite E-20 10kW</p> <p>Power management enabled and primary heater limit set to 7 kW</p> <p>Total System Load (with power management) = 15 kW - (10 kW - 7 kW) = 12 kW</p> <p>NOTE: On single phase systems, peak current draw is reduced and linearly scales with the drop in total system load. On three phase systems, peak current draw does not scale linearly with the drop in total system load.</p>
Enable Maximum Temperature Setpoint	Tap the check box to enable/disable a user defined maximum temperature setpoint. Tap the number to adjust the maximum temperature setpoint that can be entered on the home screen.
Enable Minimum Temperature Setpoint	Tap the check box to enable/disable a user defined minimum temperature setpoint. Tap the number to adjust the minimum temperature setpoint that can be entered on the home screen.

System

Use the System screen to set system settings.

Setting	Description
System Name	System name that is displayed in the Reactor Connect App.
Proportioner Type	Proportioner model type; see Models, page 4 .
Enable Custom Pump Sizes	Tap to enable/disable custom pump sizes.
Pump A Volume	Volume of the A side proportioner pump. Value is editable if Enable Custom Pump Sizes is checked.
Pump B Volume	Volume of the B side proportioner pump. Value is editable if Enable Custom Pump Sizes is checked.
MCM Digital Input/Output 1-2	Tap to select Input/Output setting for the MCM Digital Input/Output pins 1 and 2 on MCM connector 12. Input/Output Options: Disabled: Do nothing. Light Tower Red: Use to drive the red light of the accessory Light Tower Kit. Light Tower Yellow: Use to drive the yellow light of the accessory Light Tower Kit. Light Tower Green: Use to drive the green light of the accessory Light Tower Kit.
MCM Digital Input/Output 3-4	See MCM Digital Input/Output 1-2.
MCM Digital Input/Output 5-6	See MCM Digital Input/Output 1-2.
MCM Digital Input/Output 7-8	See MCM Digital Input/Output 1-2.

Supply System

Use the Supply System screen to set feed system settings.

Setting	Description
Transfer Pump A Type	Tap to select the type of transfer pump used to feed the A side of the proportioner. Transfer Pump Type Options: Air: select when using an air/pneumatic transfer pump (or other non-Graco Electric Transfer Pump). Electric: select when using with Graco Electric Transfer Pumps.
Transfer Pump B Type	Tap to select the type of transfer pump used to feed the B side of the proportioner. See Transfer Pump A Type for a list of options.

Enable Transfer Pump Runaway Alarm	Tap the checkbox to enable or disable Transfer Pump A or B Runaway alarms (DAFA or DAFB). The Transfer Pump Runaway alarms can be disabled if occurring frequently and disrupting operation. NOTE: See help.graco.com troubleshooting information for correcting issues with DAFA or DAFB alarms.
Enable Smart Supply	This feature automatically adjusts the Electric Transfer Pump pressure setpoint to maintain appropriate inlet pressure with various chemicals, ambient conditions and supply configurations. NOTE: This feature is automatically enabled when the inlet pressure sensors are enabled and at least one electric transfer pump is installed.
Max Chemical Volume	Tap to enter the chemical volume of the supply containers.
Enable Low Chemical Alarms	Tap the checkbox to enable/disable Low Chemical Alarms. Tap the number value to adjust the alarm threshold.
Enable Inlet Pressure Sensors	Tap the checkbox to enable/disable inlet pressure sensors. NOTE: Inlet pressure sensors are automatically enabled if flow meters are enabled.
Enable Inlet Temperature Sensors	Tap the checkbox to enable/disable inlet temperature sensors.
Enable Low Inlet Temperature Alarms	Tap the checkbox to enable/disable Low Inlet Temperature Alarms. Tap the number value to adjust the alarm threshold.
Enable High Inlet Temperature Alarms	Tap the checkbox to enable/disable High Inlet Temperature Alarms. Tap the number value to adjust the alarm threshold.
Request Electric Transfer Pump Calibration	Tap Electric Transfer Pump calibration button to queue an electric transfer pump calibration the next time the electric transfer pump is run. Only appears when electric transfer pumps are selected. NOTE: After pressing the button, a notice will appear on the screen notifying the user the calibration is queued.

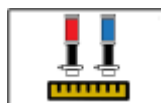

Advanced Screens

Use the Advanced Screens to manage the system cellular connection, display settings, and software.

Cellular

Use the Cellular screen to connect the Reactor Connect app to the Reactor, or to reset the Reactor Key. See your Reactor Connect manual, [Related Manuals, page 3](#).

Resetting your Reactor Key prevents other users from remotely changing or viewing Reactor settings without first reconnecting to the Reactor.

Icon	Name	Description
	Reset Key	Tap to reset the Reactor Connect Key for the system.

Setting	Description
IMEI	IMEI of the Reactor Connect App Module. This value is used to identify the device and system within the Reactor Connect App.
Key	Key used by Reactor Connect App.
Key Created	Date and time of last key creation.

After resetting your Reactor key, all operators using the Graco Reactor Connect app must reconnect to the Reactor.

For security of wireless control, change the Reactor key regularly and whenever there is a concern about unauthorized access.

Display

Use the Display screen to set the language, date format, current date, time, setup screens password, screen saver delay, temperature units, pressure units, volume units, and cycle units (pump cycles or volume).

Tap the field next to each setting to edit.

Setting	Description
Enable Demo Mode	Tap to enable/disable demo mode. NOTE: settings changed and cycles accrued in demo mode are not undone after exiting demo mode.
Language	Display language.
Number Format	Display and USB download number format.
Date Format	Display and USB download date format.
Date	Display date and time.
Screen Saver	Screen saver timeout period (zero disables the screen saver).
Password	Display password. Settings with a lock next to the entry can be password protected. NOTE: enter 0000 (default value) to disable the password.
Temperature Units	Display and USB download temperature units.
Pressure Units	Display and USB download pressure units.
Volume Units	Display and USB download volume units.

Software

The Software screen displays the system part number, system serial number, software part number, and software version.

Setting	Description
System Part #	System part number (shown on product label). NOTE: Value will be blank on replacement displays.
System Serial #	System serial number (shown on product label). NOTE: Value will be blank on replacement displays.
Software Part #	System software part number.
Software Version	System software version.
Enable Cellular Software Updates	Tap the checkbox to enable/disable cellular software updates.

Maintenance

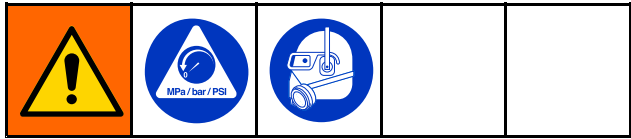

Prior to performing any maintenance procedures, follow [Pressure Relief Procedure, page 32](#).

Preventative Maintenance Schedule

The operating conditions of your particular system determine how often maintenance is required. Establish a preventive maintenance schedule by recording when and what kind of maintenance is needed, and then determine a regular schedule for checking your system.

Tools Required for Maintenance

- 9/16 in. wrench
- 1 1/8 in. wrench or pipe wrench
- Fusion grease gun

Proportioner Maintenance

Wet Cup

Check the wet cup daily. Keep it 3/4 full with Graco Throat Seal Liquid (TSL®) or compatible solvent. Do not over tighten packing nut/wet cup.

Packing Nuts

Do not over tighten packing nut/wet cup. Throat u-cup is not adjustable.

Fluid Inlet Strainer Screens

Inspect fluid inlet strainer screens daily, see [Flush Inlet Strainer Screen, page 52](#).

ISO Lubricant Level

Inspect ISO lubricant level and condition daily. Refill or replace as needed. See [Pump Lubrication System](#).

Moisture

To prevent crystallization, do not expose component A to moisture in air.

Gun Mix Chamber Ports

Clean gun mix chamber ports regularly. See your gun manual, [Related Manuals, page 3](#).

Gun Check Valve Screens

Clean the gun check valve screens regularly. See your gun manual, [Related Manuals, page 3](#).

Dust Protection

Use clean, dry, oil-free compressed air to prevent dust buildup on control modules, fans, and motor (under shield).

Vent Holes

Keep the vent holes on the back of the electrical cabinet open.

Grease Circulation Valves

Clean the grease circulation valves weekly.

Desiccant Dryer

The desiccant dryer cartridge has an indicator window. Check this window daily to ensure that the dryer cartridge is still in working condition.

When the window appears blue, the dryer cartridge is still in working condition. If the window appears pink, moisture has entered the dryer cartridge and it should be replaced.

Flush Inlet Strainer Screen

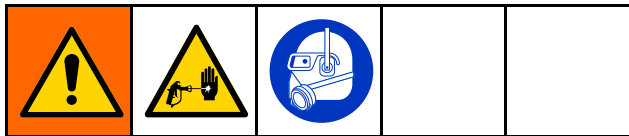

The inlet strainers filter out particles that can plug the pump inlet check valves. Inspect the screens daily as part of the startup routine and clean as required.

Isocyanate can crystallize from moisture contamination or from freezing. If the chemicals used are clean and proper storage, transfer, and operating procedures are followed, there should be minimal contamination of the A-side screen.

Clean the A-side screen only during daily startup. This minimizes moisture contamination by immediately flushing out any isocyanate residue at the start of dispensing operations.

1. Follow the [Pressure Relief Procedure](#), page 32.
2. Close the Fluid Inlet Valve (XA) at the pump inlet. This prevents material from being pumped while cleaning the screen.
3. Place a container under the strainer base to catch fluid when removing the strainer drain plug (ZB).

4. After the fluid has drained, remove inlet cap (ZC) and inlet strainer screen (ZA) from the strainer manifold. Thoroughly flush the screen with compatible solvent and shake it dry. Inspect the screen. No more than 25% of the mesh should be restricted. If more than 25% of the mesh is blocked, replace the screen. Inspect the gasket and replace as required.
5. Install the strainer plug (ZB) with the screen (ZA).
6. Open the fluid inlet valve (XA), then ensure that there are no leaks and wipe the equipment clean. Proceed with operation.

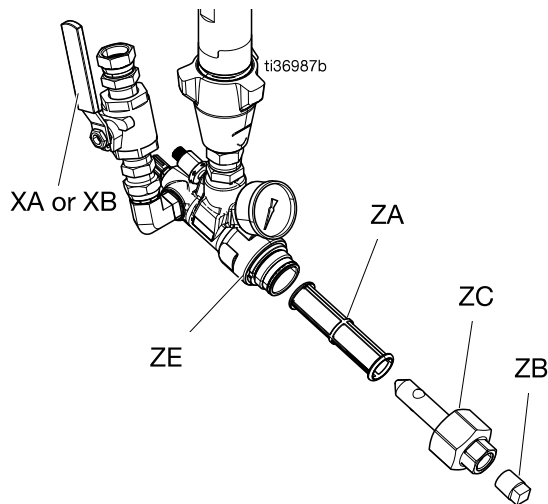

Change ISO Pump Throat Seal Lubricant (TSL) Fluid

Check the condition of the TSL fluid daily. Change the TSL fluid if it becomes a gel, its color darkens, or it becomes diluted with isocyanate.

Gel formation is due to moisture absorption by the TSL fluid. The interval between changes depends on the environment in which the equipment is operating. The TSL fluid system minimizes exposure to moisture, but some contamination is still possible.

TSL fluid discoloration is due to continual seepage of small amounts of isocyanate past the pump packings during operation. If the packings are operating properly, TSL fluid replacement due to discoloration should not be necessary more often than every 3 or 4 weeks.

To change TSL Fluid:

1. Follow [Pressure Relief Procedure, page 32](#).
2. Lift the TSL fluid reservoir (R) out of the bracket and remove the reservoir from the cap. Hold the cap over a suitable waste container and flush contaminated fluid out of the lines by placing the strainer in the new fluid and dispense contaminated fluid through the return line into the waste container.
3. Manually cycle the peristaltic pump (PP) in the diagnostic screen until all contaminated TSL fluid is removed from the system.
4. Drain the reservoir and flush it with clean TSL fluid or replace it with a new reservoir.
5. When the TSL fluid system is flushed clean, fill it with fresh TSL fluid.

6. Thread the reservoir onto the cap (H) assembly and place it in the bracket.

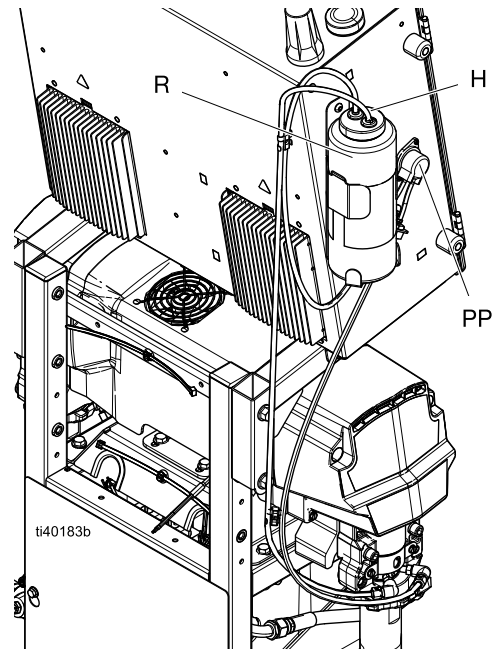

7. Verify the TSL fluid pump is operating correctly by feeling the pulsation in the return hose during normal proportioner pump operation.

Recycling and Disposal

End of Product Life

At the end of a product's useful life, recycle it in a responsible manner.

Troubleshooting

To avoid injury due to unexpected machine operation initiated by a remote controller, disconnect the Reactor Connect cellular module, if equipped, from the system prior to troubleshooting. Refer to your Reactor Connect manual for instructions.

Troubleshoot Errors

When an error occurs the error information screen displays the active error code and description. See [Logs Screens, page 46](#).

To troubleshoot an active error:

1. Tap for help with the active error.

Errors 08:39				
Date	Time	Help	Code	Description
02/17/21	13:29		T6DB	(E04) Temp. Sensor Err. B
02/17/21	13:29		V4MA	High Voltage A
02/17/21	13:29		T6DA	(E04) Temp. Sensor Err. A
02/17/21	13:29		P6FB	Press. Sens. Err. Inlet B
02/17/21	13:29		P6FA	Press. Sens. Err. Inlet A
02/17/21	13:29		T4EB	(E01) High Temp. Switch B
02/17/21	13:29		T4EA	(E01) High Temp. Switch A
02/17/21	13:29		P6BX	(E22) Press. Sens. Err. B
02/17/21	13:29		P6AX	(E21) Press. Sens. Err. A
02/17/21	13:29		A4DH	(E02) High Current Hose

Page: 3/28

2. A QR code screen will be displayed. Scan the QR code with your smart phone to be sent directly to online troubleshooting for the active error code. Otherwise, go to help.graco.com and search for the active error.

Errors 08:40				
Date	Time	Help	Code	Description
02/17/21	13:29		V4MA	High Voltage A
02/17/21	13:29		T6DB	(E04) Temp. Sensor Err. B
02/17/21	13:29		T6DA	(E04) Temp. Sensor Err. A
02/17/21	13:29		P6FB	Press. Sens. Err. Inlet B
02/17/21	13:29		P6FA	Press. Sens. Err. Inlet A
02/17/21	13:29		T4EB	(E01) High Temp. Switch B
02/17/21	13:29		T4EA	(E01) High Temp. Switch A
02/17/21	13:29		P6BX	(E22) Press. Sens. Err. B
02/17/21	13:29		P6AX	(E21) Press. Sens. Err. A
02/17/21	13:29		A4DH	(E02) High Current Hose

Page: 3/28

LED Status Descriptions

The following tables describe the meaning of LED statuses for the TCM, MCM, ADM, and System.

Table 1 TCM Module LED Status Descriptions

See [Temperature Control Module \(TCM\), page 21](#).

LED	Conditions	Description
TCM Status (TK)	Green Solid	Power applied to module
	Yellow Flashing	Active Communication
	Red Steady Flashing	Software update in progress
	Red Random Flashing or Solid	Module error exists

Table 2 MCM Module LED Status Descriptions

See [Motor Control Module \(MCM\), page 22](#).

LED	Conditions	Description
MCM Status (MU)	Green Solid	Power applied to module
	Yellow Flashing	Active Communication
	Red Steady Flashing	Software update in progress
	Red Random Flashing or Solid	Module error exists

Table 3 ADM LED Status Descriptions

See [Electrical Enclosure, page 20](#) and [Proportioner, page 18](#).

LED	Conditions	Description
ADM Status (AAS)	Green Solid	Power applied to module
	Yellow Solid	Active Communication
	Red Steady Flashing	Software update in progress
	Red Random Flashing or Solid	Module error exists
System Status (SS)	Green Flashing Fast	Software update is in progress
	Green Flashing Slow	System On

Performance Charts

Use these charts to help identify the proportioner that will work most efficiently with each mix chamber. Flow rates are based on a material viscosity of 60 cps.

NOTICE

To prevent system damage, do not pressurize the system above the line for the gun tip size being used.

Pressure/Flow Charts

E-20 and E-30

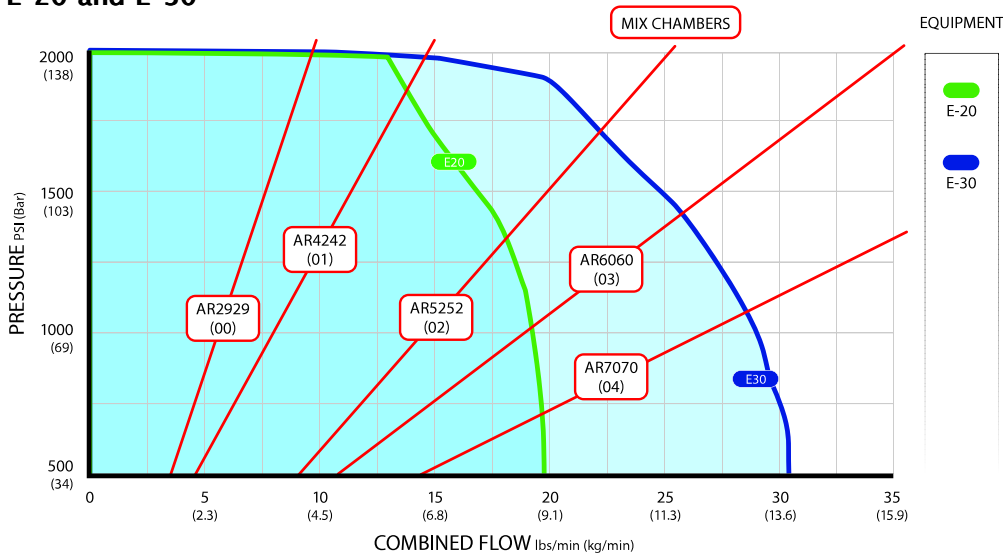

E-XP1 and E-XP2

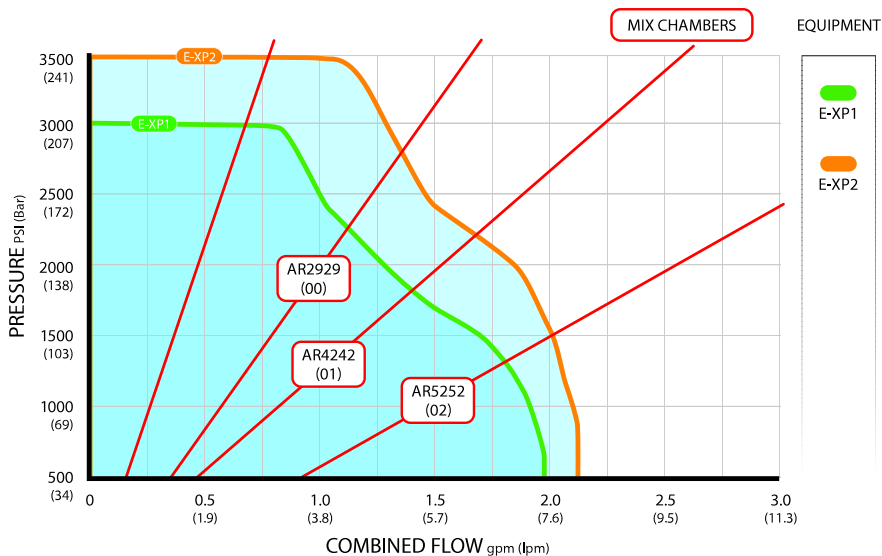

Heater Performance Chart

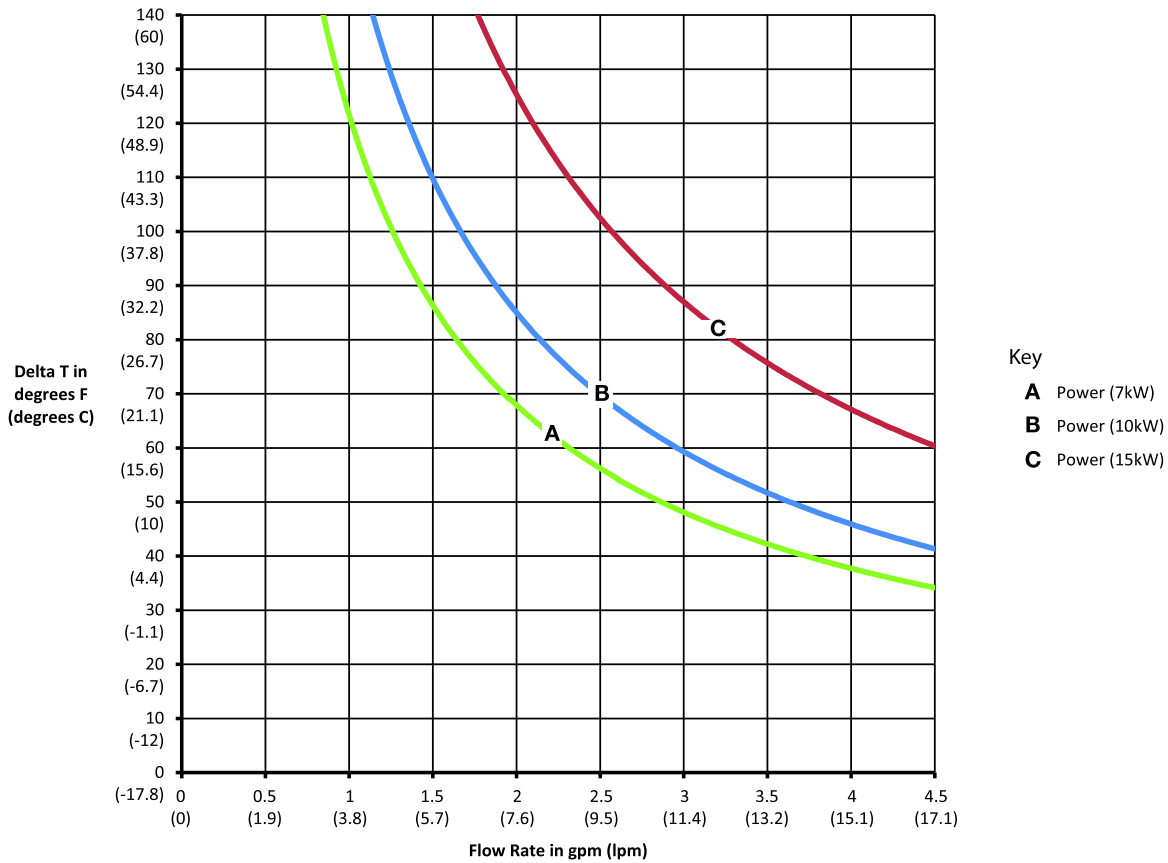

NOTE: Heater performance data is based on testing with 20 wt. hydraulic oil and 240V across heater power wires.

Internally Heated Hose Pressure Setpoint Adjustment

Internally heated hoses experience additional pressure drop when compared to externally heated hoses of the same inner diameter. The system pressure setpoint may need to be increased to offset the additional pressure drop and achieve desired pressure and pattern at the gun. Pressure drop may vary based on pressure setpoint, temperature setpoints, chemical viscosities, and hose configuration (length and number of fittings). Reference the table below as a starting point for offsetting the additional pressure drop.

Hose Length	Pressure Setpoint Adjustment
< 100 ft (30 m)	Increase 50 – 150 psi (3.4 – 10.3 bar)
100 – 200 ft (30 – 70 m)	Increase 100 – 250 psi (6.9 – 17.2 bar)
>200 ft (70 m)	Increase 150 – 350 psi (10.3 – 24.1 bar)

Internally Heated Hose Temperature Setpoint Adjustment

Temperature setpoints may need to be adjusted on internally heated hoses to address additional pressure imbalance caused by additional pressure drop. In order to balance pressures, increase the temperature of the higher pressure material and decrease the temperature of the lower pressure material. Once the imbalance is resolved, adjust the temperature setpoints up or down together to achieve the desired results.

Technical Specifications

Reactor E-20

Reactor 3 Proportioning Systems, E-20				
	U.S.		Metric	
Maximum Fluid Working Pressure	2000 psi		140 bar, 14 MPa	
Maximum Fluid Temperature	160 °F		71.1 °C	
Maximum Flow Rate	20 lb/min		9.07 kg/min	
Maximum Heated hose Length	220 ft		67 m	
Approximate Output per cycle (A+B)	0.0104 gal		39.4 cc	
Operating Ambient Temperature Range	20 °F to 120 °F		-7 °C to 49 °C	
Fluid Inlets	3/4 npt(f)			
Fluid Outlet - A	#8 (1/2 in.) JIC, with #5 (5/16 in.) JIC adapter			
Fluid Outlet - B	#10 (5/8 in.) JIC, with #6 (3/8 in.) JIC adapter			
Fluid Circulation Port Size	1/4 nps(m)			
Fluid Circulation Port Maximum Pressure	250 psi		17 bar, 1.7 MPa	
Maximum Fluid Inlet Pressure	Standard Models	Pro and Elite Models	Standard Models	Pro and Elite Models
	400 psi	600 psi	27.6 bar, 2.76 MPa	41.4 bar, 4.14 MPa
Line Voltage Requirements				
200-240 VAC, 1-ph, 50/60 Hz				
200-240 VAC, 3-ph DELTA, 50/60 Hz				
350-415 VAC, 3-ph WYE, 50/60 Hz				
Sound Pressure <i>Measured per ISO-9614-2</i>				
Measured from 3.1 ft (1 m) @ 1000 psi (7 MPa, 70 bar), 2 gpm (7.6 lpm)	90.1 dBA			
Sound Power				
Measured from 3.1 ft (1 m) @ 1000 psi (7 MPa, 70 bar), 2 gpm (7.6 lpm)	97.15 dBA			
Dimensions				
Width	24.9 in.		63 cm	
Depth	15.0 in.		38 cm	
Height	56.5 in.		144 cm	
Weight				
Elite 10 kW	270 lb		122.5 kg	
Wetted Parts				
Material	Aluminum, stainless steel, zinc-plated carbon steel, nickel-plated carbon steel, brass, tungsten carbide, chrome, chemically resistant o-rings, PTFE, acetal, ultra high molecule weight polyethylene			
Notes				
All trademarks or registered trademarks are the property of their respective owners				

Reactor E-30

Reactor 3 Proportioning Systems, E-30				
	U.S.		Metric	
Maximum Fluid Working Pressure	2000 psi		140 bar, 14 MPa	
Maximum Fluid Temperature	160 °F		71.1 °C	
Maximum Flow Rate	30 lb/min		13.5 kg/min	
Maximum Heated hose Length	320 ft		97.5 m	
Approximate Output per cycle (A+B)	0.0273 gal		103.4 cc	
Operating Ambient Temperature Range	20 °F to 120 °F		-7 °C to 49 °C	
Fluid Inlets	3/4 npt(f)			
Fluid Outlet - A	#8 (1/2 in.) JIC, with #5 (5/16 in.) JIC adapter			
Fluid Outlet - B	#10 (5/8 in.) JIC, with #6 (3/8 in.) JIC adapter			
Fluid Circulation Port Size	1/4 nps(m)			
Fluid Circulation Port Maximum Pressure	250 psi		17 bar, 1.7 MPa	
Maximum Fluid Inlet Pressure	Standard Models	Pro and Elite Models	Standard Models	Pro and Elite Models
	400 psi	600 psi	27.6 bar, 2.76 MPa	41.4 bar, 4.14 MPa
Line Voltage Requirements				
200-240 VAC, 1-ph, 50/60 Hz				
200-240 VAC, 3-ph DELTA, 50/60 Hz				
350-415 VAC, 3-ph WYE, 50/60 Hz				
Sound Pressure <i>Measured per ISO-9614-2</i>				
Measured from 3.1 ft (1 m) @ 1000 psi (7 MPa, 70 bar), 2 gpm (7.6 lpm)	87.3 dBA			
Sound Power				
Measured from 3.1 ft (1 m) @ 1000 psi (7 MPa, 70 bar), 2 gpm (7.6 lpm)	93.7 dBA			
Dimensions				
Width	26.8 in.		68 cm	
Depth	15.0 in.		38 cm	
Height	56.5 in.		144 cm	
Weight				
Elite 15 kW	335 lb		151.9 kg	
Wetted Parts				
Material	Aluminum, stainless steel, zinc-plated carbon steel, nickel-plated carbon steel, brass, tungsten carbide, chrome, chemically resistant o-rings, PTFE, acetal, ultra high molecule weight polyethylene			
Notes				
All trademarks or registered trademarks are the property of their respective owners				

Reactor E-XP1

Reactor 3 Proportioning Systems, E-XP1				
	U.S.		Metric	
Maximum Fluid Working Pressure	3000 psi		207 bar, 20.7 MPa	
Maximum Fluid Temperature	180 °F		82.2 °C	
Maximum Flow Rate	2 gpm		7.6 lpm	
Maximum Heated hose Length	220 ft		67 m	
Approximate Output per cycle (A+B)	0.0104 gal		39.4 cc	
Operating Ambient Temperature Range	20 °F to 120 °F		-7 °C to 49 °C	
Fluid Inlets	3/4 npt(f)			
Fluid Outlet - A	#8 (1/2 in.) JIC, with #5 (5/16 in.) JIC adapter			
Fluid Outlet - B	#10 (5/8 in.) JIC, with #6 (3/8 in.) JIC adapter			
Fluid Circulation Port Size	1/4 nps(m)			
Fluid Circulation Port Maximum Pressure	250 psi		17 bar, 1.7 MPa	
Maximum Fluid Inlet Pressure	Standard Models	Pro and Elite Models	Standard Models	Pro and Elite Models
	400 psi	600 psi	27.6 bar, 2.76 MPa	41.4 bar, 4.14 MPa
Line Voltage Requirements				
200-240 VAC, 1-ph, 50/60 Hz				
200-240 VAC, 3-ph DELTA, 50/60 Hz				
350-415 VAC, 3-ph WYE, 50/60 Hz				
Sound Pressure <i>Measured per ISO-9614-2</i>				
Measured from 3.1 ft (1 m) @ 3000 psi (21 MPa, 207 bar), 1 gpm (11.4 lpm)	85.1 dBA			
Sound Power				
Measured from 3.1 ft (1 m) @ 3000 psi (21 MPa, 207 bar), 1 gpm (11.4 lpm)	92.15 dBA			
Dimensions				
Width	24.9 in.		63 cm	
Depth	15.0 in.		38 cm	
Height	56.5 in.		144 cm	
Weight				
Elite 10 kW	270 lb		122.5 kg	
Wetted Parts				
Material	Aluminum, stainless steel, zinc-plated carbon steel, nickel-plated carbon steel, brass, tungsten carbide, chrome, chemically resistant o-rings, PTFE, acetal, ultra high molecule weight polyethylene			
Notes				
All trademarks or registered trademarks are the property of their respective owners				

Reactor E-XP2

Reactor 3 Proportioning Systems, E-XP2				
	U.S.		Metric	
Maximum Fluid Working Pressure	3500 psi		241 bar, 24.1 MPa	
Maximum Fluid Temperature	180 °F		82.2 °C	
Maximum Flow Rate	2.1 gpm		7.94 lpm	
Maximum Heated hose Length	320 ft		97.5 m	
Approximate Output per cycle (A+B)	0.0203 gal		77.1 cc	
Operating Ambient Temperature Range	20 °F to 120 °F		-7 °C to 49 °C	
Fluid Inlets	3/4 npt(f)			
Fluid Outlet - A	#8 (1/2 in.) JIC, with #5 (5/16 in.) JIC adapter			
Fluid Outlet - B	#10 (5/8 in.) JIC, with #6 (3/8 in.) JIC adapter			
Fluid Circulation Port Size	1/4 nps(m)			
Fluid Circulation Port Maximum Pressure	250 psi		17 bar, 1.7 MPa	
Maximum Fluid Inlet Pressure	Standard Models	Pro and Elite Models	Standard Models	Pro and Elite Models
	400 psi	600 psi	27.6 bar, 2.76 MPa	41.4 bar, 4.14 MPa
Line Voltage Requirements				
200-240 VAC, 1-ph, 50/60 Hz				
200-240 VAC, 3-ph DELTA, 50/60 Hz				
350-415 VAC, 3-ph WYE, 50/60 Hz				
Sound Pressure <i>Measured per ISO-9614-2</i>				
Measured from 3.1 ft (1 m) @ 3000 psi (21 MPa, 207 bar), 1 gpm (11.4 lpm)	79.6 dBA			
Sound Power				
Measured from 3.1 ft (1 m) @ 3000 psi (21 MPa, 207 bar), 1 gpm (11.4 lpm)	86.6 dBA			
Dimensions				
Width	26.8 in.		68 cm	
Depth	15.0 in.		38 cm	
Height	56.5 in.		144 cm	
Weight				
Elite 15 kW	330 lb		149.7 kg	
Wetted Parts				
Material	Aluminum, stainless steel, zinc-plated carbon steel, nickel-plated carbon steel, brass, tungsten carbide, chrome, chemically resistant o-rings, PTFE, acetal, ultra high molecule weight polyethylene			
Notes				
All trademarks or registered trademarks are the property of their respective owners				

California Proposition 65

CALIFORNIA RESIDENTS



WARNING: Cancer and reproductive harm — www.P65warnings.ca.gov.

Graco Extended Warranty for Reactor® Components

Graco warrants all equipment referenced in this document which is manufactured by Graco and bearing its name to be free from defects in material and workmanship on the date of sale to the original purchaser for use. With the exception of any special, extended, or limited warranty published by Graco, Graco will, for a period of twelve months from the date of sale, repair or replace any part of the equipment determined by Graco to be defective. This warranty applies only when the equipment is installed, operated and maintained in accordance with Graco's written recommendations.

Graco Part Number	Description	Warranty Period
25R357	Electric Motor, 1.75 HP	36 Months
25R359	Electric Motor, 2.5 HP	36 Months
18B011	Motor Control Module	36 Months
25P036	Temperature Control Module	36 Months
18E139	Advanced Display Module	36 Months
All other Reactor 3 parts		12 Months

This warranty does not cover, and Graco shall not be liable for general wear and tear, or any malfunction, damage or wear caused by faulty installation, misapplication, abrasion, corrosion, inadequate or improper maintenance, negligence, accident, tampering, or substitution of non-Graco component parts. Nor shall Graco be liable for malfunction, damage or wear caused by the incompatibility of Graco equipment with structures, accessories, equipment or materials not supplied by Graco, or the improper design, manufacture, installation, operation or maintenance of structures, accessories, equipment or materials not supplied by Graco.

This warranty is conditioned upon the prepaid return of the equipment claimed to be defective to an authorized Graco distributor for verification of the claimed defect. If the claimed defect is verified, Graco will repair or replace free of charge any defective parts. The equipment will be returned to the original purchaser transportation prepaid. If inspection of the equipment does not disclose any defect in material or workmanship, repairs will be made at a reasonable charge, which charges may include the costs of parts, labor, and transportation.

THIS WARRANTY IS EXCLUSIVE, AND IS IN LIEU OF ANY OTHER WARRANTIES, EXPRESS OR IMPLIED, INCLUDING BUT NOT LIMITED TO WARRANTY OF MERCHANTABILITY OR WARRANTY OF FITNESS FOR A PARTICULAR PURPOSE.

Graco's sole obligation and buyer's sole remedy for any breach of warranty shall be as set forth above. The buyer agrees that no other remedy (including, but not limited to, incidental or consequential damages for lost profits, lost sales, injury to person or property, or any other incidental or consequential loss) shall be available. Any action for breach of warranty hereunder must be brought within the latter of two (2) years of the date of sale, or one (1) year the warranty period expires.

GRACO MAKES NO WARRANTY, AND DISCLAIMS ALL IMPLIED WARRANTIES OF MERCHANTABILITY AND FITNESS FOR A PARTICULAR PURPOSE, IN CONNECTION WITH ACCESSORIES, EQUIPMENT, MATERIALS OR COMPONENTS SOLD BUT NOT MANUFACTURED BY GRACO. These items sold, but not manufactured by Graco (such as electric motors, switches, hose, etc.), are subject to the warranty, if any, of their manufacturer. Graco will provide purchaser with reasonable assistance in making any claim for breach of these warranties.

In no event will Graco be liable for indirect, incidental, special or consequential damages resulting from Graco supplying equipment hereunder, or the furnishing, performance, or use of any products or other goods sold hereto, whether due to a breach of contract, breach of warranty, the negligence of Graco, or otherwise.

FOR GRACO CANADA CUSTOMERS

The Parties acknowledge that they have required that the present document, as well as all documents, notices and legal proceedings entered into, given or instituted pursuant hereto or relating directly or indirectly hereto, be drawn up in English. Les parties reconnaissent avoir convenu que la rédaction du présente document sera en Anglais, ainsi que tous documents, avis et procédures judiciaires exécutés, donnés ou intentés, à la suite de ou en rapport, directement ou indirectement, avec les procédures concernées.

Graco Information

For the latest information about Graco products, visit www.graco.com.

For patent information, see www.graco.com/patents.

To place an order, contact your Graco Distributor or call to identify the nearest distributor.

Phone: 612-623-6921 **or Toll Free:** 1-800-328-0211 **Fax:** 612-378-3505

All written and visual data contained in this document reflects the latest product information available at the time of publication.

Graco reserves the right to make changes at any time without notice.

For patent information, see www.graco.com/patents.

Original Instructions. This manual contains English. MM 3A8500

Graco Headquarters: Minneapolis

International Offices: Belgium, China, Japan, Korea

GRACO INC. AND SUBSIDIARIES • P.O. BOX 1441 • MINNEAPOLIS MN 55440-1441 • USA

Copyright 2021, Graco Inc. All Graco manufacturing locations are registered to ISO 9001.

www.graco.com

Revision D, May 2022