



Reactor[®] 3 Heated Hose

3A7683F

EN

For use with Reactor 3 proportioners. For professional use only. Not approved for use in explosive atmospheres or hazardous (classified) locations.

130 psi (0.9 MPa, 9 bar) Maximum Air Working Pressure

*See page 3 for model information, including approvals. See **Technical Specifications** on page 25 for Maximum Fluid Working Pressure and Maximum Hose Operating Temperature.*



Important Safety Instructions

Read all warnings and instructions in this manual and in your Reactor 3 manual before using the equipment. Save these instructions.

Contents

Contents 2

Related Manuals..... 2

Overview 2

Hose Bundle Part Numbers..... 3

 Whip Hoses 3

 Reactor 3 Main Hoses 3

 Fluid Temperature Sensor Kits..... 3

Warnings 4

Important Isocyanate (ISO) Information..... 7

 Isocyanate Conditions 7

 Material Self-Ignition 8

 Keep Components A and B Separate 8

 Moisture Sensitivity of Isocyanates 8

 Foam Resins with 245 fa Blowing Agents 8

 Changing Materials 8

Component Identification 9

Installation..... 10

 Grounding 10

 Connect Hoses to Proportioner..... 11

 Connecting Hose Bundle Sections 12

 Connect Whip Hose to Gun or Gun Manifold . . 13

 Check Hoses for Leaks 13

 Protective Covering 14

Operation..... 15

 Hose Control Modes 16

 Pressure Relief Procedure 16

Maintenance 17

 Replacing Individual A or B Hose 17

 Preventative Maintenance 17

Recycling and Disposal 17

 End of Product Life 17

Parts 18

 Internally Heated Hose (25P437) 18

 Externally Heated Hose 20

 Whip Hose (25P775) 22

Accessories..... 24

Technical Specifications 25

California Proposition 65 25

Graco Standard Warranty 26

Related Manuals

Manual in English	Description
3A8500	Reactor 3 Proportioning Systems Operation Manual
3A8559	Fluid Temperature Sensor Kit Manual
3A8605	Electrical Connectors Kit Manual

Overview

The heated hose maintains set fluid temperature while spraying. Fluid hoses are marked with red tape for ISO/hardener/minor volume side (A-side) and blue tape for RES/resin/major volume side (B-side). Hoses are 50 ft and 100 ft long. The whip hose is 20 ft or less.

Hose Bundle Part Numbers

Whip Hoses

Part Number	Length ft (m)	Inner Diameter in. (mm)	Heat Type	Heated Length ft (m)	Xtreme-Wrap™ Scuff Jacket	Hose Fittings		Approvals	
						“A” inlet (female)/outlet (male)	“B” inlet (female)/outlet (male)		
2000 psi (13,8 MPa, 138 bar)									
25P775	10 (3.04)	1/4 (6.35)	External	8 (2.4)	X	-05 JIC	-06 JIC		
25P776	20 (6.09)	1/4 (6.35)	External	18 (5.4)	X	-05 JIC	-06 JIC		
19D576	20 (6.09)	1/4 (6.35)	External	19.5 (5.94)	X	-05 JIC	-06 JIC		
3500 psi (24,1 MPa, 241 bar)									
25P777	10 (3.04)	1/4 (6.35)	External	9.5 (2.89)	X	-05 JIC	-06 JIC		
25P778	20 (6.09)	1/4 (6.35)	External	19.5 (5.94)	X	-05 JIC	-06 JIC		

Reactor 3 Main Hoses







Part Number	Length ft (m)	Inner Diameter in. (mm)	Temperature Sensor Cable	Heat Type	Hose Fittings		A	B
					“A” inlet (female)/outlet (male)	“B” inlet (female)/outlet (male)	Hose	Hose
								
2000 psi (13,8 MPa, 138 bar)								
25P434	50 (15.2)	3/8 (9.53)		Internal	-05 JIC	-06 JIC	18F762	18F766
25P435	100 (30.48)	3/8 (9.53)		Internal	-05 JIC	-06 JIC	18F763	18F767
25P437	50 (15.2)	3/8 (9.53)	X	Internal	-05 JIC	-06 JIC	18F762	18F766
25P438	100 (30.48)	3/8 (9.53)	X	Internal	-05 JIC	-06 JIC	18F763	18F767
96B101	50 (15.2)	3/8 (9.53)		External	-05 JIC	-06 JIC	18F772	18F773
96B125	50 (15.2)	3/8 (9.53)	X	External	-05 JIC	-06 JIC	18F772	18F773
3500 psi (24,1 MPa, 241 bar)								
25P534	50 (15.2)	3/8 (9.53)		Internal	-05 JIC	-06 JIC	18F764	18F768
25P535	100 (30.48)	3/8 (9.53)		Internal	-05 JIC	-06 JIC	18F765	18F769
25P537	50 (15.2)	3/8 (9.53)	X	Internal	-05 JIC	-06 JIC	18F764	18F768
25P538	100 (30.48)	3/8 (9.53)	X	Internal	-05 JIC	-06 JIC	18F765	18F769
96B111	50 (15.2)	3/8 (9.53)		External	-05 JIC	-06 JIC	18F774	18F775
96B145	50 (15.2)	3/8 (9.53)	X	External	-05 JIC	-06 JIC	18F774	18F775

Fluid Temperature Sensor Kits

Part Number	“A” Side			“B” Side		
	Inlet	Outlet	FTS Probe	Inlet	Outlet	FTS Probe
18E175	-5 JIC	-5 JIC	X	-6 JIC	-6 JIC	X

Warnings

The following warnings are for the setup, use, grounding, maintenance, and repair of this equipment. The exclamation point symbol alerts you to a general warning and the hazard symbols refer to procedure-specific risks. When these symbols appear in the body of this manual or on warning labels, refer back to these Warnings. Product-specific hazard symbols and warnings not covered in this section may appear throughout the body of this manual where applicable.

 <h2 style="margin: 0;">WARNING</h2>	
  	<p>SKIN INJECTION HAZARD</p> <p>High-pressure fluid from hose leaks, or ruptured components will pierce skin. This may look like just a cut, but it is a serious injury that can result in amputation. Get immediate surgical treatment.</p> <ul style="list-style-type: none"> • Inspect hose before each use for cuts, bulges, kinks or any other damage. • Replace damaged hose immediately. • Replace hoses proactively at regular intervals based on your operating conditions. • Tighten all fluid connections before operating the equipment. • Keep clear of leaks. • Do not stop or deflect leaks with your hand, body, glove, or rag. • Never exceed hose Maximum Pressure or Temperature ratings. • Only use chemicals that are compatible with hose materials. See Technical Specifications in this manual. Read Safety Data Sheets (SDSs) and fluid and solvent manufacturer’s recommendations. • Follow the Pressure Relief Procedure when you stop spraying/dispersing and before cleaning, checking, or servicing equipment.
	<p>TOXIC FLUID OR FUMES HAZARD</p> <p>Toxic fluids or fumes can cause serious injury or death if splashed in the eyes or on skin, inhaled or swallowed.</p> <ul style="list-style-type: none"> • Read Safety Data Sheets (SDSs) for handling instructions and to know the specific hazards of the fluids you are using, including the effects of long-term exposure. • When spraying, servicing equipment, or when in the work area, always keep work area well-ventilated and always wear appropriate personal protective equipment. See Personal Protective Equipment warnings in this manual. • Store hazardous fluid in approved containers, and dispose of it according to applicable guidelines.
	<p>PERSONAL PROTECTIVE EQUIPMENT</p> <p>Always wear appropriate personal protective equipment and cover all skin when spraying, servicing equipment, or when in the work area. Protective equipment helps prevent serious injury, including long-term exposure; inhalation of toxic fumes, mists or vapors; allergic reaction; burns; eye injury and hearing loss. This protective equipment includes but is not limited to:</p> <ul style="list-style-type: none"> • A properly fitting respirator, which may include a supplied-air respirator, chemically impermeable gloves, protective clothing and foot coverings as recommended by the fluid manufacturer and local regulatory authority. • Protective eyewear and hearing protection.
	<p>BURN HAZARD</p> <p>Equipment surfaces and fluid that is heated can become very hot during operation. To avoid severe burns:</p> <ul style="list-style-type: none"> • Do not touch hot fluid or equipment.



WARNING



FIRE AND EXPLOSION HAZARD

Flammable fumes, such as solvent and paint fumes, in **work area** can ignite or explode. Paint or solvent flowing through the equipment can cause static sparking. To help prevent fire and explosion:



- Use equipment only in well-ventilated area.
- Eliminate all ignition sources; such as pilot lights, cigarettes, portable electric lamps, and plastic drop cloths (potential static sparking).
- Ground all equipment in the work area. See **Grounding** instructions.
- Never spray or flush solvent at high pressure.
- Keep work area free of debris, including solvent, rags and gasoline.
- Do not plug or unplug power cords, or turn power or light switches on or off when flammable fumes are present.
- Use only grounded hoses.
- Hold gun firmly to side of grounded pail when triggering into pail. Do not use pail liners unless they are anti-static or conductive.
- **Stop operation immediately** if static sparking occurs or you feel a shock. Do not use equipment until you identify and correct the problem.
- Keep a working fire extinguisher in the work area.



EQUIPMENT MISUSE HAZARD

Misuse can cause death or serious injury.



- Do not operate the unit when fatigued or under the influence of drugs or alcohol.
- Do not exceed the maximum working pressure or temperature rating of the lowest rated system component. See **Technical Specifications** in all equipment manuals.
- Use fluids and solvents that are compatible with equipment wetted parts. See **Technical Specifications** in all equipment manuals. Read fluid and solvent manufacturer's warnings. For complete information about your material, request Safety Data Sheets (SDSs) from distributor or retailer.
- Do not leave the work area while equipment is energized or under pressure.
- Turn off all equipment and follow the **Pressure Relief Procedure** when equipment is not in use.
- Check equipment daily. Repair or replace worn or damaged parts immediately with genuine manufacturer's replacement parts only.
- Do not alter or modify equipment. Alterations or modifications may void agency approvals and create safety hazards.
- Make sure all equipment is rated and approved for the environment in which you are using it.
- Use equipment only for its intended purpose. Call your distributor for information.
- Route hoses and cables away from traffic areas, sharp edges, moving parts, and hot surfaces.
- Do not kink or over bend hoses or use hoses to pull equipment.
- Keep children and animals away from work area.
- Comply with all applicable safety regulations.



PRESSURIZED ALUMINUM PARTS HAZARD

Use of fluids that are incompatible with aluminum in pressurized equipment can cause serious chemical reaction and equipment rupture. Failure to follow this warning can result in death, serious injury, or property damage.

- Do not use 1,1,1-trichloroethane, methylene chloride, other halogenated hydrocarbon solvents or fluids containing such solvents.
- Do not use chlorine bleach.
- Many other fluids may contain chemicals that can react with aluminum. Contact your material supplier for compatibility.

WARNING



THERMAL EXPANSION HAZARD

Fluids subjected to heat in confined spaces, including hoses, can create a rapid rise in pressure due to the thermal expansion. Over-pressurization can result in equipment rupture and serious injury.

- Open a valve to relieve the fluid expansion during heating.
- Replace hoses proactively at regular intervals based on your operating conditions.



ELECTRIC SHOCK HAZARD

The hoses must be grounded. Improper grounding, set-up, or usage of hoses can cause electric shock.

- Turn off and disconnect power before installing or servicing hoses.
- Connect only to grounded power source.
- All electrical wiring must be done by a qualified electrician and comply with all local codes and regulations.
- Never cut or puncture a hose cover.
- Do not expose to rain. Store indoors.



Important Isocyanate (ISO) Information

Isocyanates (ISO) are catalysts used in two component materials.

Isocyanate Conditions

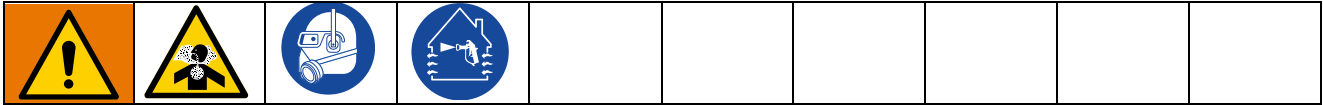



Spraying or dispensing fluids that contain isocyanates creates potentially harmful mists, vapors, and atomized particulates.

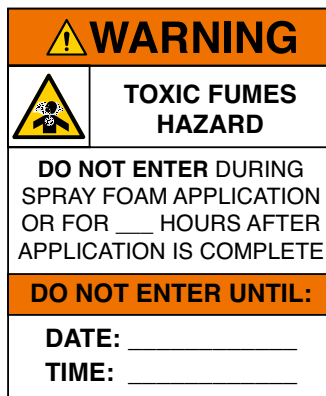

- Read and understand the fluid manufacturer’s warnings and Safety Data Sheets (SDSs) to know specific hazards and precautions related to isocyanates.
- Use of isocyanates involves potentially hazardous procedures. Do not spray with this equipment unless you are trained, qualified, and have read and understood the information in this manual and in the fluid manufacturer’s application instructions and SDSs.
- Use of incorrectly maintained or mis-adjusted equipment may result in improperly cured material, which could cause off gassing and offensive odors. Equipment must be carefully maintained and adjusted according to instructions in the manual.
- To prevent inhalation of isocyanate mists, vapors and atomized particulates, everyone in the work area must wear appropriate respiratory protection. Always wear a properly fitting respirator, which may include a supplied-air respirator. Ventilate the work area according to instructions in the fluid manufacturer’s SDSs.
- Avoid all skin contact with isocyanates. Everyone in the work area must wear chemically impermeable gloves, protective clothing and foot coverings as recommended by the fluid manufacturer and local regulatory authority. Follow all fluid manufacturer recommendations, including those regarding handling of contaminated clothing. After spraying, wash hands and face before eating or drinking.
- Hazard from exposure to isocyanates continues after spraying. Anyone without appropriate personal protective equipment must stay out of the work area during application and after application for the time period specified by the fluid manufacturer. Generally this time period is at least 24 hours.
- Warn others who may enter work area of hazard from exposure to isocyanates. Follow the recommendations of the fluid manufacturer and local regulatory authority. Posting a placard such as the following outside the work area is recommended:



Material Self-Ignition

				
Some materials may become self-igniting if applied too thick. Read material manufacturer's warnings and material Safety Data Sheets (SDSs).				

Keep Components A and B Separate

				
Cross-contamination can result in cured material in fluid lines which could cause serious injury or damage equipment. To prevent cross-contamination:				
<ul style="list-style-type: none">• Never interchange component A and component B wetted parts.• Never use solvent on one side if it has been contaminated from the other side.				

Moisture Sensitivity of Isocyanates

Exposure to moisture (such as humidity) will cause ISO to partially cure, forming small, hard, abrasive crystal that become suspended in the fluid. Eventually a film will form on the surface and the ISO will begin to gel, increasing in viscosity.

NOTICE

Partially cured ISO will reduce performance and the life of all wetted parts.

- Always use a sealed container with a desiccant dryer in the vent, or a nitrogen atmosphere. **Never** store ISO in an open container.
- Keep the ISO pump wet cup or reservoir (if installed) filled with appropriate lubricant. The lubricant creates a barrier between the ISO and the atmosphere.
- Use only moisture-proof hoses compatible with ISO.
- Never use reclaimed solvents, which may contain moisture. Always keep solvent containers closed when not in use.
- Always lubricate threaded parts with an appropriate lubricant when reassembling.

NOTE: The amount of film formation and rate of crystallization varies depending on the blend of ISO, the humidity, and the temperature.

Foam Resins with 245 fa Blowing Agents

Some foam blowing agents will froth at temperatures above 90°F (33°C) when not under pressure, especially if agitated. To reduce frothing, minimize preheating in a circulation system.

Changing Materials

NOTICE

Changing the material types used in your equipment requires special attention to avoid equipment damage and downtime.

- When changing materials, flush the equipment multiple times to ensure it is thoroughly clean.
- Always clean the fluid inlet strainers after flushing.
- Check with your material manufacturer for chemical compatibility.
- When changing between epoxies and urethanes or polyureas, disassemble and clean all fluid components and change hoses. Epoxies often have amines on the B (hardener) side. Polyureas often have amines on the B (resin) side.

Component Identification

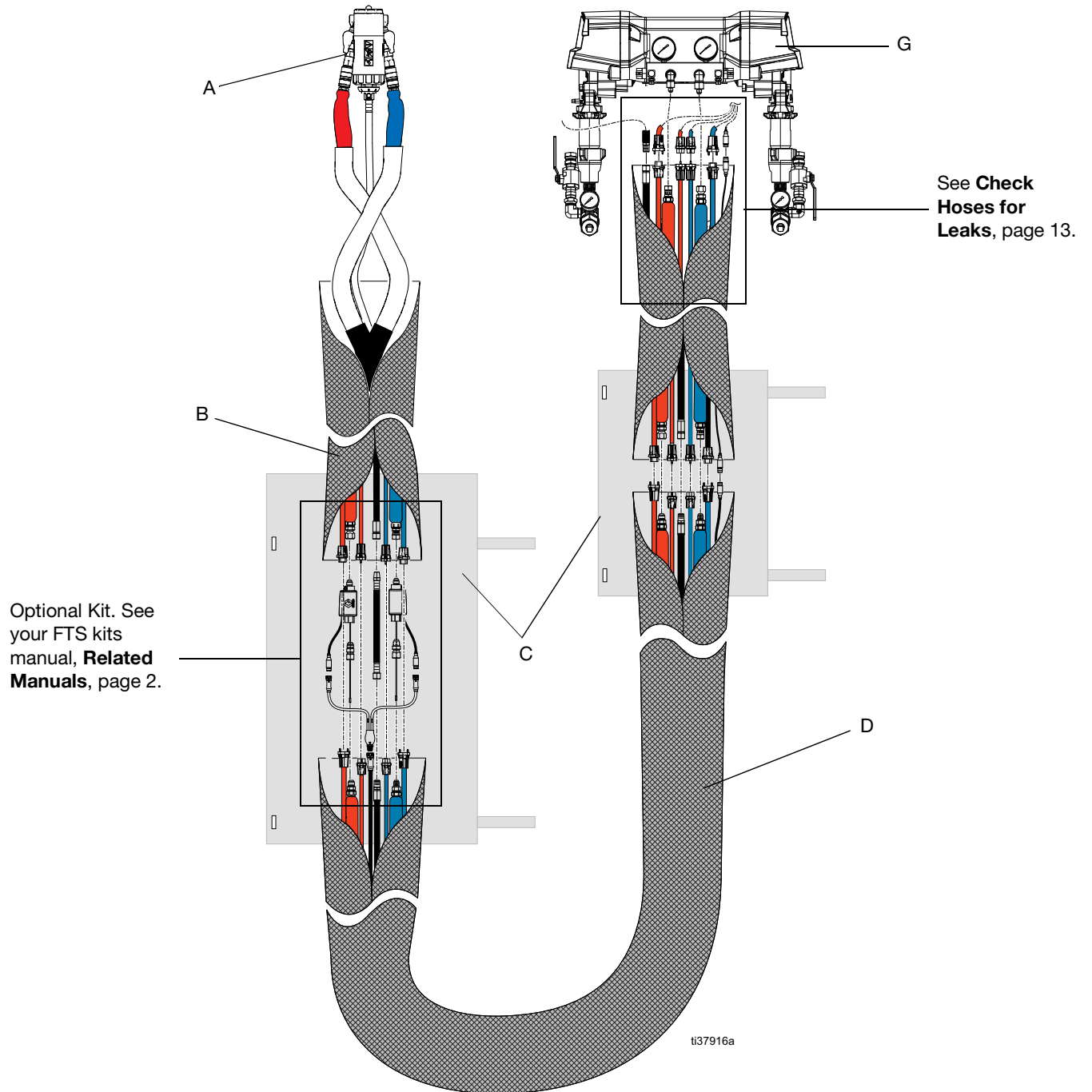

Ref.	Description
A	Gun
B	Whip Hose
C	Joint Protector
D	Main Hose Bundle
G	Reactor

Installation

<p>Reactor 3 heated hoses are designed for use only with Graco Reactor 3 proportioners.</p> <p>To reduce the risk of fire and serious injury, never connect these hoses to any other device.</p>				

<p>This equipment is used with heated fluid, which can cause equipment surfaces to become very hot. To avoid severe burns:</p> <ul style="list-style-type: none"> • Do not touch hot fluid or equipment. • Do not turn on hose heat without fluid in hoses. • Allow equipment to cool completely before touching it • Wear gloves if fluid temperature exceeds 110°F (43°C). 				

NOTICE				
<p>Incorrect connection of fittings can cause fluid crossover and permanently damage the hose. Fittings have different sized threads to prevent incorrect connection. Only connect fittings with matching thread sizes.</p>				

NOTICE				
<p>Heated hose must always contain fluid when hose power is on. Never apply power to an empty heated hose. Powering empty hoses may cause equipment damage.</p>				

NOTICE				
<p>Always completely unroll and bleed the air from the hose before each use. If the air is not bled from the hose, heat transfer from the heating conductor will not be uniform. In the worst case, the heating element can be damaged. The warranty is void in such cases.</p>				

Grounding

<p>The equipment must be grounded to reduce the risk of static sparking and electric shock. Electric or static sparking can cause fumes to ignite or explode. Improper grounding can cause electric shock. Grounding provides an escape wire for the electric current.</p>				

Whip Hose

- Hose core is statically conductive

Internally Heated Main Hose

- Hose core is statically conductive

Externally Heated Main Hose

- Grounded through conductive air line

NOTE: To effectively dissipate static, the entire grounding path from proportioner to gun must be less than 29 megohms.

Connect Hoses to Proportioner



NOTICE

Heated hose must always contain fluid when hose power is on. Never apply power to an empty heated hose. Powering empty hoses may cause equipment damage.

NOTICE

Always completely unroll and bleed the air from the hose before each use. If the air is not bled from the hose, heat transfer from the heating conductor will not be uniform. In the worst case, the conductor can be damaged. The warranty is void in such cases.

1. Connect the fluid hoses (FH) to the proportioner fluid manifold (G). The red fluid hose is for hardener (component A, ISO), and the blue fluid hose is for resin (component B, RES).

NOTE: Torque hoses to 3/8 in. (9.5 mm) inner diameter hoses to:

- A side to 14 ft-lb (19 N•m)
- B side to 20 ft-lb (27 N•m)

NOTE: Ensure the hose fittings are facing away from the proportioner.

2. Connect electrical wires (EW). Tighten the electrical connector screws.

NOTE: Torque the electrical connector screws to 3-6 in-lb. Do not over-tighten the connector screws.

NOTE: When connecting electrical wires, ensure that red wires are connected to red wires and blue wires are connected to blue wires.

3. Connect the air hose (AH).
4. Check that all equipment is properly grounded. See **Grounding**, page 10.

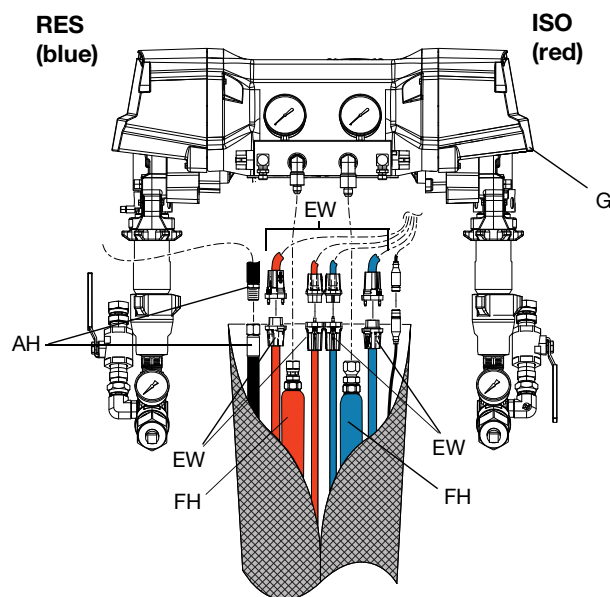

Connecting Hose Bundle Sections

To connect internally heated hoses and whip hoses to another hose:

1. Lay the heated hoses end-to-end. Align the fluid hoses (FH) red to red (component A, ISO) and blue to blue (component B, RES).
2. Connect the fluid hoses (FH) and tighten the connections finger tight, then fully tighten the connections with wrenches.

NOTE: Torque hoses to 3/8 in. (9.5 mm) ID hoses to:

- A side to 14 ft-lb (19 N•m).
- B side to 20 ft-lb (27 N•m).

NOTE: When connecting the fluid hoses, ensure that red hoses are connected to red hoses and blue hoses are connected to blue hoses.

3. Connect the air hoses (AH) and tighten the connections finger tight, then fully tighten the connectors with wrenches.

4. Connect electrical wires (EW). Tighten the electrical connector screws.

NOTE: Torque electrical connector screws to 3-6 in-lb Do not over-tighten the connector screws.

NOTE: When connecting the electrical wires, ensure that red wires are connected to red wires and blue wires are connected to blue wires.

5. **For hoses with RTD cables:** Connect the RTD cables (RTD) and tighten the connections.

NOTE: RTD Cables are an optional accessory and only needed when the FTS kit is used.

6. Tape excess electrical wire (EW) to the fluid hoses (FH). Stagger the electrical connectors as shown to create the smallest joint bundle possible.

7. **Check Hoses for Leaks**, page 13.

8. Cover the joint with protective covering. See **Protective Covering**, page 14.

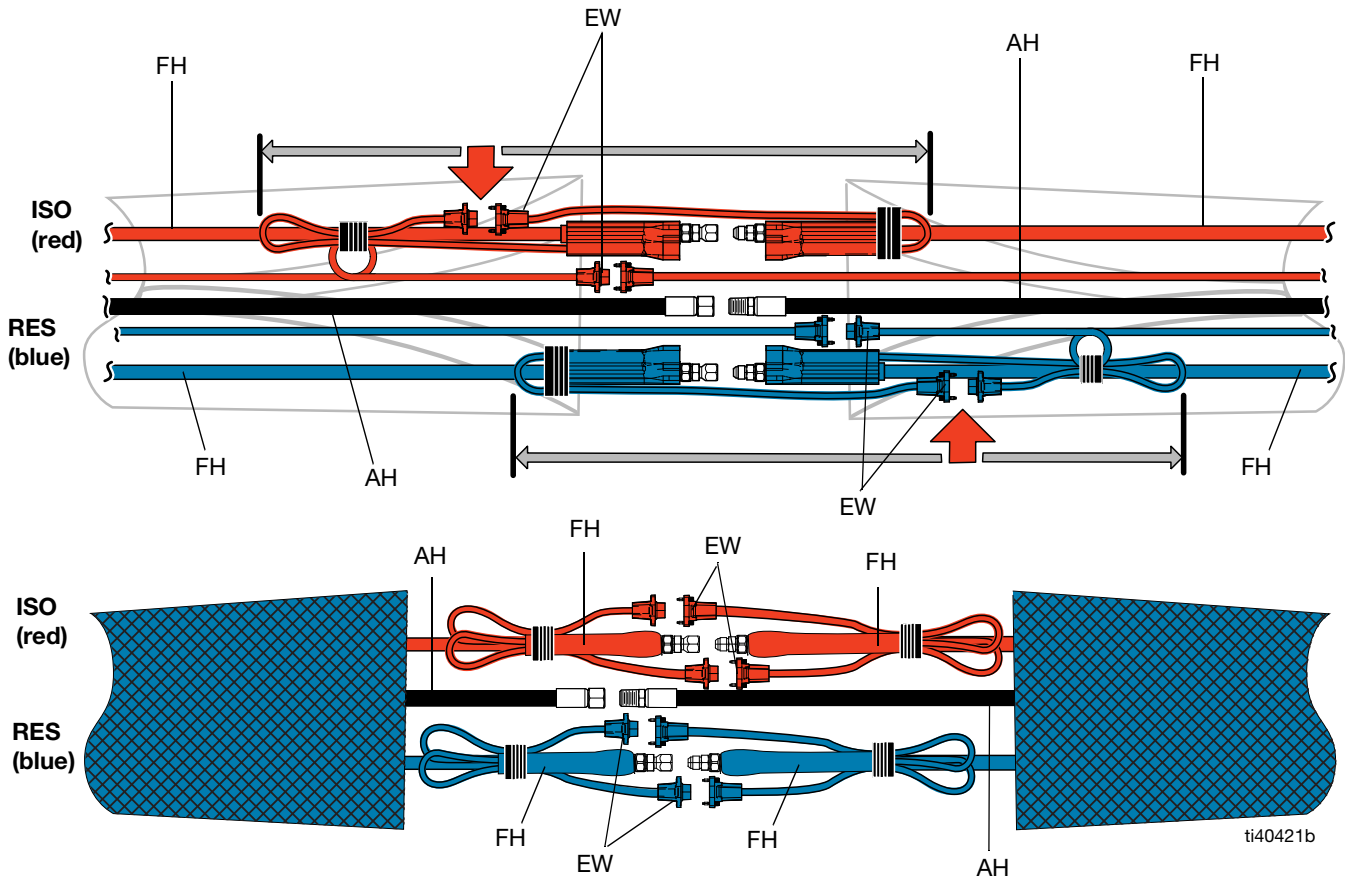

Connect Whip Hose to Gun or Gun Manifold

Install hose in a helix configuration for:

- Easy gun movement
- Large spraying motion
- Ability to spray in tight areas and odd angles
- Reduced operator fatigue
- Maximum hose life

1. Overlap A and B component hoses and assemble to gun or gun manifold fittings.
2. Tighten fittings to A-side and B-side component hoses. Ensure gun or gun manifold remain flat after fittings are tightened. Loosen and re-tighten fittings as necessary to eliminate any undesired twisting in the gun or gun manifold.

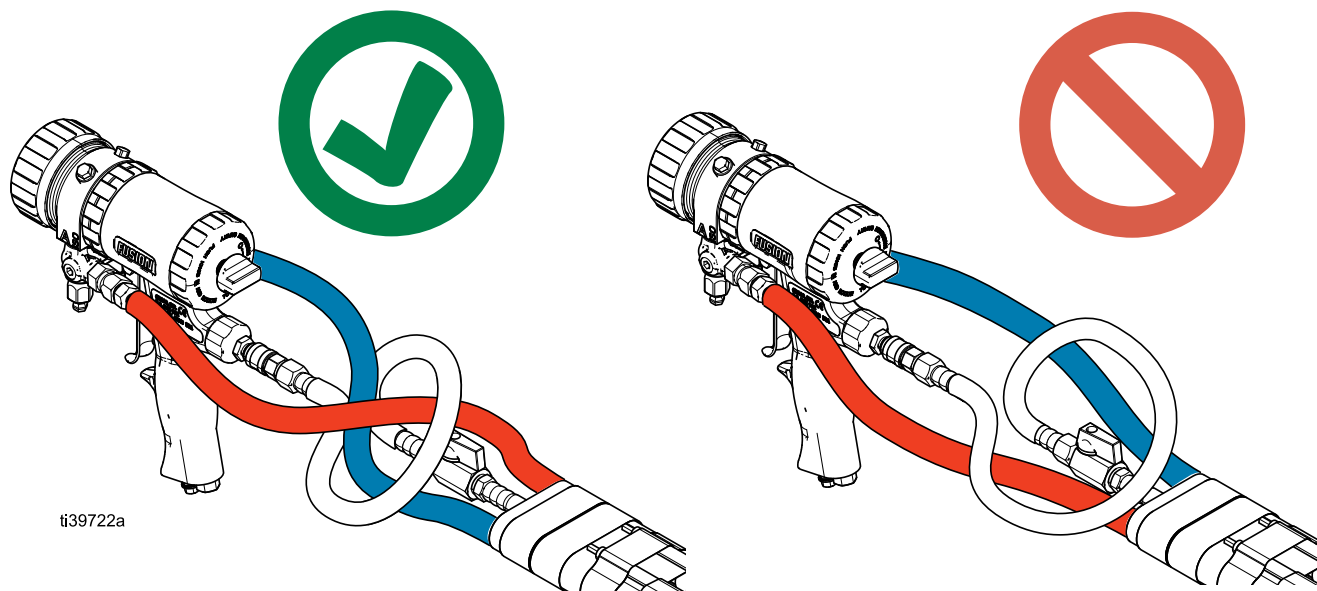

Check Hoses for Leaks



1. Fill the hose with material. See the Startup procedure in your Reactor 3 Proportioning System manual for instructions on filling hoses with material for the first time. See **Related Manuals**, page 2.
2. After all lines are free of air, check for leaks. Visually inspect fluid connections to ensure they are dry and no material is leaking. If there are leaks, follow the Pressure Relief Procedure in your Reactor 3 Proportioning System manual. See **Related Manuals**, page 2.
3. If leaks are found, tighten connections, then pressurize again to ensure leaks have stopped.

Protective Covering

Hoses with Hook and Loop Scuff Jackets

1. Lay the joint protector (C) flat and center under the joint. Ensure the hook and loop on the outside of the hose scuff jackets (SJ) and the inside of the joint protector (C) connect.
2. Open the top of the hose scuff jacket (SJ).
3. Alternate stacking the scuff jacket (SJ) and joint protector (C) to create an interlocking joint as shown.

- a. Connect the double-sided hook and loop of the joint protector to the inner layer of the scuff jacket.
- b. Connect the outer layer of the scuff jacket to the joint protector.
- c. Connect the outer layer of the joint protector to the inner layer of the joint protector.

Hoses with Hook and Loop Scuff Jackets

Pull the excess scuff jacket over the joint and secure with tape as shown below.

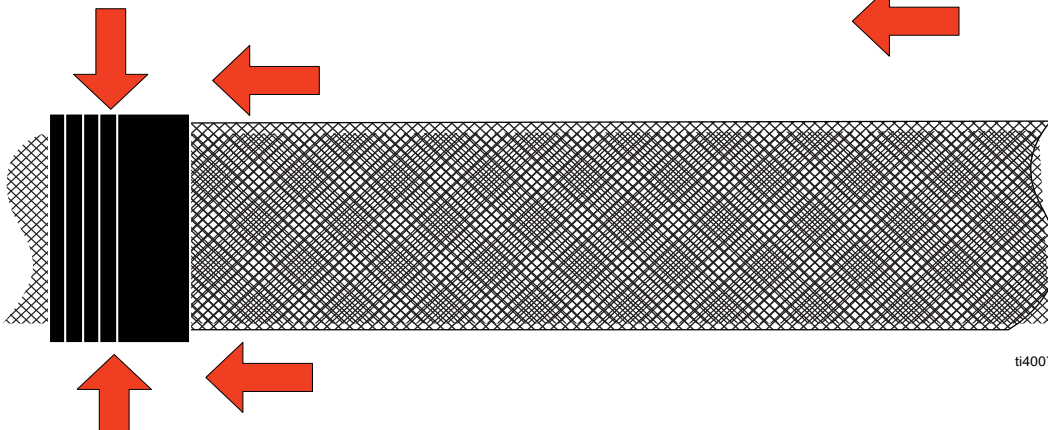
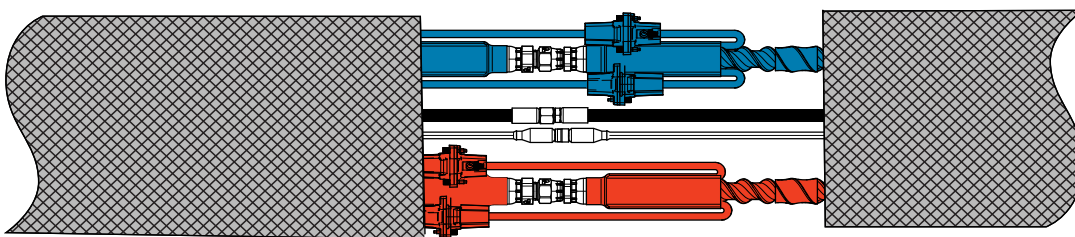
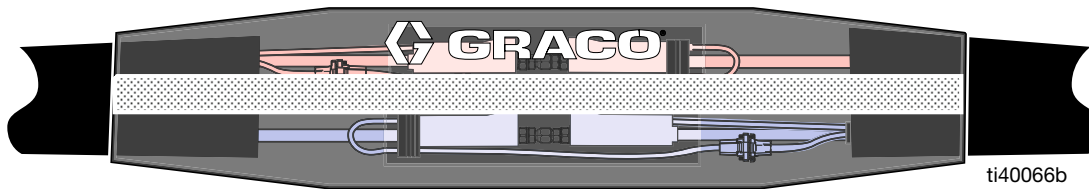
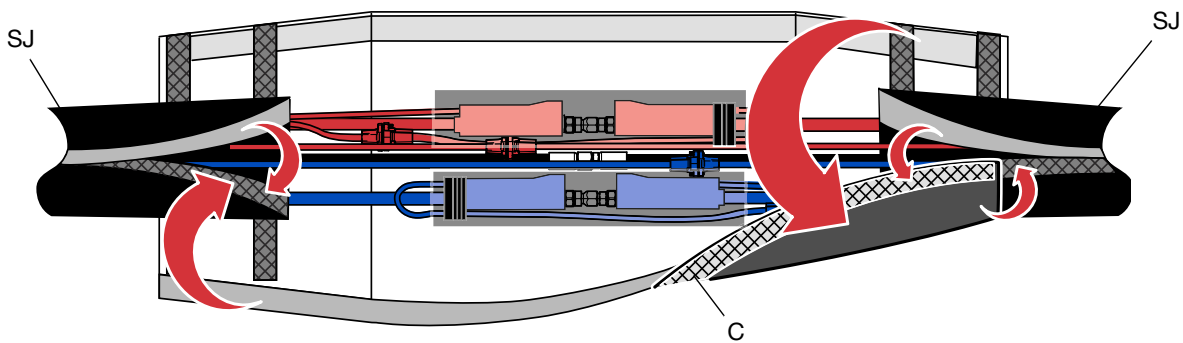

Operation

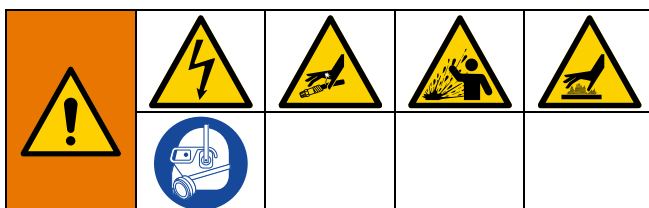

Do not operate a coiled hose. A coiled hose creates uneven heat buildup, which can result in hose rupture and cause serious injury, including skin injection.

Do not exceed maximum hose operating temperature. See **Technical Specifications**, page 25, for maximum allowable operating temperature.

Hose must be properly supported to avoid excessive strain due to weight, bending, sharp edges, or stress caused by running over a roof edge.

Fluid subjected to heat in confined spaces, including hoses, can create a rapid rise in pressure due to thermal expansion. Over-pressurization can result in equipment rupture and serious injury.

To prevent over-pressurization caused by thermal expansion:

- Open a valve to relieve the fluid expansion during heating.
- Replace hoses pro-actively at regular intervals based on your operating conditions.

NOTICE

Heated hose must always contain fluid when hose power is on. Never apply power to an empty heated hose. Powering empty hoses may cause equipment damage.

NOTICE

Always completely unroll and bleed the air from the hose before each use. If the air is not bled from the hose, heat transfer from the heating conductor will not be uniform. In the worst case, the conductor can be damaged. The warranty is void in such cases.

1. Connect air hose to main air supply.
2. Connect spray gun to gun fluid manifold. See your spray gun manual for further details.

NOTE: For best handling of gun, see page for 12 for proper hose connection.
3. Connect whip air hose to gun air inlet if equipped. See your gun manual.
4. Follow Setup, Startup, and Operation procedures in your Reactor 3 Proportioning System manual.

Hose Control Modes

The target temperature of component materials can be controlled using one of three hose control modes. Set your preferred hose control mode using the Advanced Display Module on the Reactor system. See your proportioner manual to set the hose control mode. See **Related Manuals**, page 2.

Hose Control Mode	Description
FTS Mode	The fluid temperature sensor (FTS) installed in the hose automatically controls the hose fluid temperature. This mode requires the FTS to be installed and working properly. See your FTS kit manual, Related Manuals , on page 2.
Resistance Mode	The hose heater element resistance automatically controls hose fluid temperature. This mode does not use an FTS. This mode requires a calibration factor (see your proportioner manual).
Manual Control Mode	Control to target current (amps) to heat the hose. Manual control mode has no pre-programmed control and is designed to be used for a limited amount of time until a proper calibration can be performed or FTS issues can be resolved.

Pressure Relief Procedure



This equipment stays pressurized until pressure is manually relieved. To help prevent serious injury from pressurized fluid, such as skin injection and splashing fluid, follow the Pressure Relief Procedure when you stop spraying and before cleaning, checking, or servicing the equipment.

Before disconnecting or repairing hoses, relieve all fluid pressure and shut off electrical power to proportioner.

Follow the **Pressure Relief Procedure** in your Reactor Proportioning System manual. See **Related Manuals**, on page 2.

Maintenance

1. Before disconnecting or repairing hoses, relieve all fluid pressure and shut off electrical power to the proportioner. See your proportioner manual. See **Related Manuals**, on page 2.
2. Make sure all fluid is cool before disconnecting hoses.

Replacing Individual A or B Hose

Internally Heated Hoses

1. Disconnect all electrical connections.
2. Disconnect fluid connections.
3. Flush and clear out all material from hose.
4. Install new hose in bundle, wrapping around other fluid hose and air hose.
5. Complete installation (see **Installation**, on page 10).

Externally Heated Hoses

1. Disconnect all electrical connections.
2. Disconnect fluid connections.
NOTE: If removing the A Side hose, cut the ground wire jumper in order to remove the hose from the bundle.
3. Flush and clear out all material from hose.
4. Install the new hose in the bundle, wrapping around other fluid hose and air hose.
5. Complete installation (see **Installation**, on page 10).
NOTE: If removing the A Side hose, the grounding jumper needs to be connected to the hose fitting at the proportioner only. Check the grounding path (see **Grounding**, on page 10).

Preventative Maintenance

To ensure the heated hose functions properly, regularly perform the following preventative maintenance procedures on a monthly basis:

- Visually inspect the scuff jacket for defects. Replace if tears or rips are found.
- Inspect electrical connections to ensure they are properly connected and housing are in good condition.

Recycling and Disposal

End of Product Life

At the end of a product's life, recycle it in a responsible manner.

Parts

Internally Heated Hose (25P437)

NOTE: The hose model is shown with the optional sensor cable, but is representative of all internally Heated Hoses.

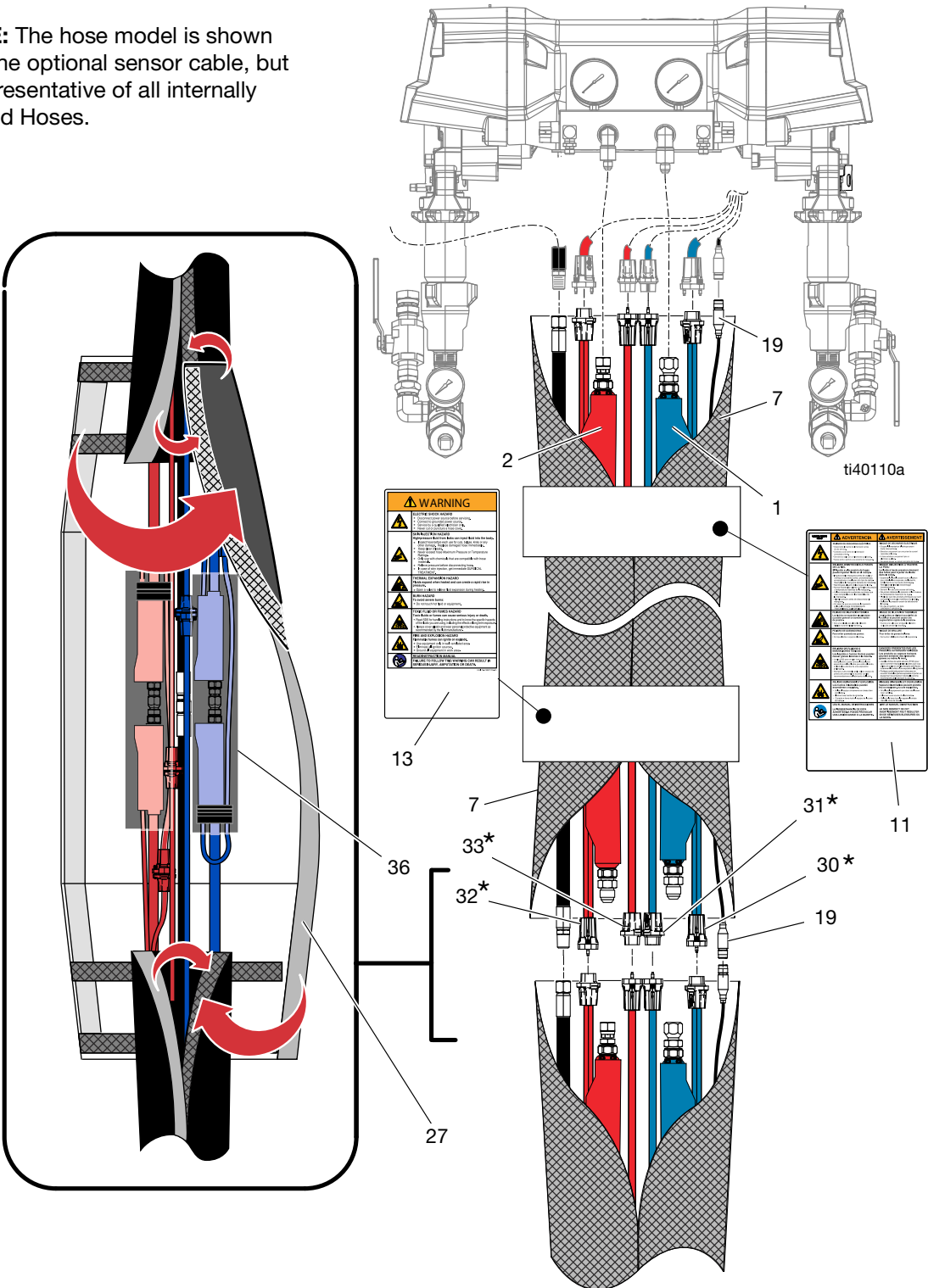

Internally Heated Hose Parts List

Ref.	Part	Description	Qty.
1	18F762	HOSE, Reactor 3, internally heated, 3/8 in., a, 2000, 50 ft	1
2	18F766	HOSE, Reactor 3, internally heated, 3/8 in., b, 2000, 50 ft	1
7	18E176	JACKET, Hook and Loop, Reactor 3, 50 ft	1
11▲	16M219	LABEL, safety, warn, mult, htd hose	1
13▲	15B679	LABEL, safety, warn, mult, htd hose	1
19	18E185	CABLE, m12, 5-pin-mf, molded, 15 m	1
27	18E178	JACKET, Hook and Loop, Reactor 3, joint	1
30*	-----	CONNECTOR, socket, ISO	1
31*	-----	CONNECTOR, pin, ISO	1
32*	-----	CONNECTOR, socket, RES	1
33*	-----	CONNECTOR, pin, RES	1

▲ Replacement safety labels, tags, and cards are available at no cost.

* Replacement parts available in Electrical Connectors Kit 18E184 (purchase separately).

Externally Heated Hose

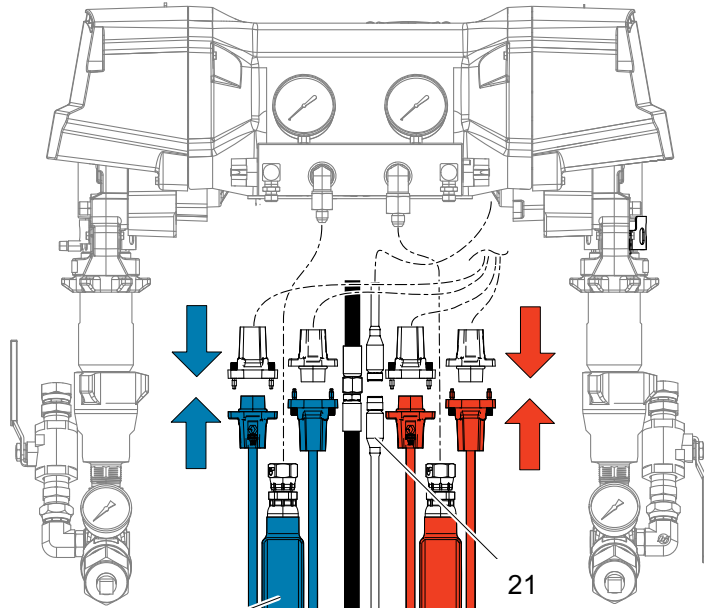

WARNING	
	ELECTRIC SHOCK HAZARD • Disconnect power source before servicing. • Connect to grounded power source. • Service by a qualified electrician only. • Never out or puncture a hose cover.
	SKIN INJECTION HAZARD High-pressure fluid from hoses can inject fluid into the body. • Inspect hose before each use for cuts, bulges, kinks or any other damage. Replace damaged hose immediately. • Keep clear of hoses. • Never exceed hose Maximum Pressure or Temperature Ratings. • Only use with chemicals that are compatible with hose materials. • Relieve pressure before disconnecting hose. • In case of skin injection, get immediate SURGICAL TREATMENT.
	THERMAL EXPANSION HAZARD Fluids expand when heated and can create a rapid rise in pressure. • Open a valve to relieve fluid expansion during heating.
	BURN HAZARD To avoid severe burns: • Do not touch hot fluid or equipment.
	TOXIC FLUID OR FUMES HAZARD Toxic fluids or fumes can cause serious injury or death. • Read SDS for handling instructions and to know the specific hazards of the fluids you are using, including the effects of long term exposure. • Always cover all skin and wear personal protective equipment as recommended by the fluid manufacturer.
	FIRE AND EXPLOSION HAZARD Flammable fumes can ignite or explode. • Use equipment only in well ventilated areas. • Eliminate all ignition sources. • Ground all equipment in work area.
	READ INSTRUCTION MANUAL FAILURE TO FOLLOW THIS WARNING CAN RESULT IN SERIOUS INJURY, AMPUTATION OR DEATH.

ADVERTENCIA		AVERTISSEMENT	
	RIESGO DE DESCARGA ELÉCTRICA • Desconecte la fuente de alimentación antes de realizar el mantenimiento. • Conecte a una fuente de alimentación correctamente aterrada. • Solo debe ser servido por un electricista calificado. • Nunca toque ni dañe el aislamiento de ninguna manera.		RIEUSO DE DÉCHARGE ÉLECTRIQUE • Coupez la source d'alimentation avant de réaliser les opérations de maintenance. • Connectez-vous à une source d'alimentation correctement mise à terre. • Seul un électricien qualifié doit effectuer les opérations de maintenance. • Ne touchez ni ne détérioriez jamais l'isolation.
	RIESGO DE INYECCIÓN A TRAVÉS DE LA PIEL El fluido a alta presión de fugas puede inyectar fluido en el cuerpo. • Inspeccione la manguera antes de cada uso en busca de cortes, abultamientos, nudos u otros daños. Reemplace la manguera dañada inmediatamente. • Manténgase alejado de las mangueras. • Nunca exceda las calificaciones de presión o temperatura máximas de la manguera. • Solo use con los productos químicos compatibles con los materiales de la manguera. • Alivie la presión antes de desconectar la manguera. • En caso de inyección en la piel, busque atención médica inmediata.		RIEUSO D'INJECTION A TRAVERS DE LA PEAU Le fluide à haute pression émergeant des fuites peut injecter du fluide dans le corps. • Inspectez la conduite avant chaque utilisation en recherchant des coupures, des gonflements, des nœuds ou d'autres dommages. Remplacez immédiatement la conduite endommagée. • Gardez-vous à l'écart des conduites. • Ne dépassez jamais les limites de pression ou de température maximales de la conduite. • Utilisez uniquement des produits chimiques compatibles avec les matériaux de la conduite. • Déchargez la pression avant de déconnecter la conduite. • En cas d'injection dans la peau, consultez immédiatement un médecin.
	RIESGO DE EXPANSIÓN TÉRMICA Los fluidos se expanden cuando se calientan y pueden crear un aumento rápido de la presión. • Abra una válvula para aliviar la expansión de los fluidos durante el calentamiento.		RIEUSO DE EXPANSION TERMICA Los fluidos se expanden cuando se calientan y pueden crear un aumento rápido de la presión. • Abra una válvula para aliviar la expansión de los fluidos durante el calentamiento.
	RIESGO DE QUEMADURAS Para evitar quemaduras graves: • No toque el fluido o el equipo que esté caliente.		RIEUSO DE QUEMADURAS Para evitar quemaduras graves: • No toque el fluido o el equipo que esté caliente.
	RIESGO DE FLUIDOS O FUMOS TOXICOS Los fluidos o los vapores tóxicos pueden causar lesiones graves o la muerte. • Lea las fichas de datos de seguridad y conozca los peligros específicos de los fluidos que está utilizando, incluidos los efectos de la exposición a largo plazo. • Siempre cubra toda la piel y use el equipo de protección personal recomendado por el fabricante del fluido.		RIEUSO DE PRODUCTOS DAÑOSOS O FUMOS TOXICOS Los fluidos o los vapores tóxicos pueden causar lesiones graves o la muerte. • Lea las fichas de datos de seguridad y conozca los peligros específicos de los fluidos que está utilizando, incluidos los efectos de la exposición a largo plazo. • Siempre cubra toda la piel y use el equipo de protección personal recomendado por el fabricante del fluido.
	RIESGO DE INCENDIO Y EXPLOSION Los vapores inflamables pueden encenderse o explotar. • Use el equipo solo en áreas bien ventiladas. • Elimine todas las fuentes de ignición. • Conecte a tierra todo el equipo en el área de trabajo.		RIEUSO DE INCENDIO Y EXPLOSION Los vapores inflamables pueden encenderse o explotar. • Use el equipo solo en áreas bien ventiladas. • Elimine todas las fuentes de ignición. • Conecte a tierra todo el equipo en el área de trabajo.
	LEA EL MANUAL DE INSTRUCCIONES LA NO OBEDECENCIA DE ESTO PUEDE RESULTAR EN LESIONES GRAVES O LA MUERTE.		LEA EL MANUAL DE INSTRUCCION LE NON RESPECT DE CET AVERTISSEMENT PEUT RESULTER EN DE SERIEUSES BLESURES OU LA MORT.

Externally Heated Hose Parts List

Ref.	Part	Description	Qty.
1	18F772	HOSE, Reactor 3, internally heated, 3/8 in., A, 2000, 50 ft	1
2	18F773	HOSE, Reactor 3, internally heated, 3/8 in., B, 2000, 50 ft	1
4	18E182	KIT, R3 mesh jacket, 50 ft	1
11▲	15B679	LABEL, safety, warn, mult, htd hose	1
13▲	16M219	LABEL, safety, warn, mult, htd hose	1
21	18E185	KIT, R3 FTS cable, 50 ft	1
24*	-----	CONNECTOR, socket, ISO	2
25*	-----	CONNECTOR, pin, ISO	2
26*	-----	CONNECTOR, socket, RES	2
27*	-----	CONNECTOR, pin, RES	2

▲ Replacement safety labels, tags, and cards are available at no cost.

* Replacement parts available in Electrical Connectors Kit 18E184 (purchase separately).

Whip Hose Parts List

Ref.	Part	Description	Qty.
1	-----	HOSE, assy, ISO, Reactor 3, 2000 psi,10 ft	1
2	-----	HOSE, assy, RES, Reactor 3, 2000 psi,10 ft	1
7	-----	HOSE, air, 9.25 ft	1
12	18E179	JACKET, scuff, Reactor 3, whip,10 ft	1
14▲	15B679	LABEL, safety, warn, mult, htd hose	1
17▲	16M219	LABEL, safety, warn, mult, htd hose	1
22*	-----	CONNECTOR, socket, ISO	1
24*	-----	CONNECTOR, pin, ISO	1
25*	-----	CONNECTOR, socket, RES	1
26*	-----	CONNECTOR, pin, RES	1

▲ Replacement safety labels, tags, and cards are available at no cost.

* Replacement parts available in Electrical Connectors Kit 18E184 (purchase separately).

Accessories

Part	Description
18E175	Reactor 3 Heated Hose FTS Kit
18E187	Dual FTS Adapter Cable
18E176	Reactor 3 Hook and Loop Wrap 50 ft
18E177	Reactor 3 Hook and Loop Wrap 100 ft
18E184	Electrical Connector Kit
18E185	Reactor 3 Heated Hose FTS Cable 50 ft
18E186	Reactor 3 FTS Cable 100 ft
18E182	Reactor Heated Hose Mesh Scuff Jacket 50 ft

Technical Specifications

Reactor 3 Heated Hose		
	US	Metric
Whip Hose		
Maximum Fluid Working Pressure		
25P775	2000 psi	14 MPa, 138 bar
25P776	2000 psi	14 MPa, 138 bar
19D576	2000 psi	14 MPa, 138 bar
25P777	3500 psi	24 MPa, 241 bar
25P778	3500 psi	24 MPa, 241 bar
Two Component Hose		
Maximum Fluid Working Pressure		
25P434	2000 psi	14 MPa, 138 bar
25P435	2000 psi	14 MPa, 138 bar
25P437	2000 psi	14 MPa, 138 bar
25P438	2000 psi	14 MPa, 138 bar
25P534	3500 psi	24 MPa, 241 bar
25P535	3500 psi	24 MPa, 241 bar
25P537	3500 psi	24 MPa, 241 bar
25P538	3500 psi	24 MPa, 241 bar
Hose		
Maximum Operating Temperature		
2000 psi	160 °F	71.1 °C
3500 psi	180 °F	82.2 °C
Wetted Parts		
Material	Chemically resistant polymeric material, stainless steel, plated carbon steel	
Notes		
All trademarks or registered trademarks are the property of their respective owners.		

California Proposition 65

CALIFORNIA RESIDENTS

 **WARNING:** Cancer and reproductive harm – www.P65warnings.ca.gov.

Graco Standard Warranty

Graco warrants all equipment referenced in this document which is manufactured by Graco and bearing its name to be free from defects in material and workmanship on the date of sale to the original purchaser for use. With the exception of any special, extended, or limited warranty published by Graco, Graco will, for a period of twelve months from the date of sale, repair or replace any part of the equipment determined by Graco to be defective. This warranty applies only when the equipment is installed, operated and maintained in accordance with Graco's written recommendations.

This warranty does not cover, and Graco shall not be liable for general wear and tear, or any malfunction, damage or wear caused by faulty installation, misapplication, abrasion, corrosion, inadequate or improper maintenance, negligence, accident, tampering, or substitution of non-Graco component parts. Nor shall Graco be liable for malfunction, damage or wear caused by the incompatibility of Graco equipment with structures, accessories, equipment or materials not supplied by Graco, or the improper design, manufacture, installation, operation or maintenance of structures, accessories, equipment or materials not supplied by Graco.

This warranty is conditioned upon the prepaid return of the equipment claimed to be defective to an authorized Graco distributor for verification of the claimed defect. If the claimed defect is verified, Graco will repair or replace free of charge any defective parts. The equipment will be returned to the original purchaser transportation prepaid. If inspection of the equipment does not disclose any defect in material or workmanship, repairs will be made at a reasonable charge, which charges may include the costs of parts, labor, and transportation.

THIS WARRANTY IS EXCLUSIVE, AND IS IN LIEU OF ANY OTHER WARRANTIES, EXPRESS OR IMPLIED, INCLUDING BUT NOT LIMITED TO WARRANTY OF MERCHANTABILITY OR WARRANTY OF FITNESS FOR A PARTICULAR PURPOSE.

Graco's sole obligation and buyer's sole remedy for any breach of warranty shall be as set forth above. The buyer agrees that no other remedy (including, but not limited to, incidental or consequential damages for lost profits, lost sales, injury to person or property, or any other incidental or consequential loss) shall be available. Any action for breach of warranty must be brought within two (2) years of the date of sale.

GRACO MAKES NO WARRANTY, AND DISCLAIMS ALL IMPLIED WARRANTIES OF MERCHANTABILITY AND FITNESS FOR A PARTICULAR PURPOSE, IN CONNECTION WITH ACCESSORIES, EQUIPMENT, MATERIALS OR COMPONENTS SOLD BUT NOT MANUFACTURED BY GRACO. These items sold, but not manufactured by Graco (such as electric motors, switches, hose, etc.), are subject to the warranty, if any, of their manufacturer. Graco will provide purchaser with reasonable assistance in making any claim for breach of these warranties.

In no event will Graco be liable for indirect, incidental, special or consequential damages resulting from Graco supplying equipment hereunder, or the furnishing, performance, or use of any products or other goods sold hereto, whether due to a breach of contract, breach of warranty, the negligence of Graco, or otherwise.

FOR GRACO CANADA CUSTOMERS

The Parties acknowledge that they have required that the present document, as well as all documents, notices and legal proceedings entered into, given or instituted pursuant hereto or relating directly or indirectly hereto, be drawn up in English. Les parties reconnaissent avoir convenu que la rédaction du présente document sera en Anglais, ainsi que tous documents, avis et procédures judiciaires exécutés, donnés ou intentés, à la suite de ou en rapport, directement ou indirectement, avec les procédures concernées.

Graco Information

For the latest information about Graco products, visit www.graco.com.

For patent information, see www.graco.com/patents.

TO PLACE AN ORDER, contact your Graco distributor or call to identify the nearest distributor.

Phone: 612-623-6921 **or Toll Free:** 1-800-328-0211, **Fax:** 612-378-3505

All written and visual data contained in this document reflects the latest product information available at the time of publication. Graco reserves the right to make changes at any time without notice.

Original instructions. This manual contains English. MM 3A7683

Graco Headquarters: Minneapolis

International Offices: Belgium, China, Japan, Korea

GRACO INC. AND SUBSIDIARIES • P.O. BOX 1441 • MINNEAPOLIS MN 55440-1441 • USA
Copyright 2020, Graco Inc. All Graco manufacturing locations are registered to ISO 9001.

www.graco.com
Revision F, August 2022